

Reference Manual for **Ambu[®] aView[™] 2 Advance**

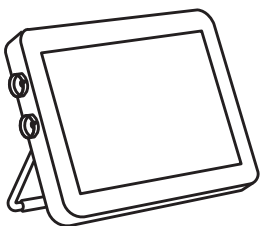

For use by trained clinicians/physicians,
qualified technicians and qualified professionals only.
For in-hospital use.
For use with Ambu[®] visualization devices.



Ambu is a registered trademark and aScope and aView are trademarks of Ambu A/S.

Content

1. Important information	4
2. Device overview	4
3. Setting up the displaying unit	5
3.1. Turning power ON and OFF	5
3.2. Choosing connector port orientation	5
3.3. Placing the displaying unit on a solid surface	6
3.4. Mounting the displaying unit on a pole	6
3.5. Power button light indications	7
3.6. Charging the displaying unit	7
3.7. Battery status on the graphical user interface	8
3.8. Connecting an Ambu visualization device	8
3.9. Connecting to external screens using HDMI or SDI	9
3.10. Connecting to Wi-Fi and local area network (LAN)	9
3.11. Connecting USB storage devices	9
4. Setting up the displaying unit software	10
4.1. How to log in	10
4.2. System setup	11
4.2.1. System language	12
4.2.2. Date and Time	13
4.2.3. Network setup	13
4.2.4. PACS setup	16
4.2.5. General settings	18
4.3. User profiles	19
4.3.1. User types	19
4.3.2. Create and edit user profiles	20
4.3.3. Password requirement	21
5. Operating the displaying unit	22
5.1. Live View (main screen)	22
5.1.1. Adjusting live image appearance	23
5.1.2. Rotation of live image 180 degrees	25
5.1.3. Recording images and videos	26
5.1.4. Access recorded images and videos in Current Procedure folder	26
5.1.5. Zoom	27
5.1.6. Dual View	28
5.2. Archive	29
5.2.1. Viewing Procedure Folder in Archive	31
5.2.2. Adding a procedure note	31
5.2.3. Viewing recordings	32
5.2.4. Deleting files	33
5.2.5. Export to USB or PACS	34
6. System information and upgrade	35
6.1. Monitor information page	35
6.2. System upgrade	36
6.3. Reporting a Problem	37
6.3.1. Export Log Files	37
6.4. Backup	37
Appendix 1. Electromagnetic Compatibility	38
Appendix 2. Radio Frequency Compliance	41
Appendix 3. Cybersecurity	44

1. Important information

This is a reference manual for Ambu® aView™ 2 Advance, item number 405011000, software version 1.0.0. The reference manual may be updated without further notice. The latest version of the reference manual is available online at www.ambu.com.

In this reference manual, the term *displaying unit* refers to aView 2 Advance. Please be aware that this manual does not explain or discuss clinical procedures. The reference manual describes only information and functions related to the operation of the aView 2 Advance.

Before operating the displaying unit, please read the Instruction for Use (IFU) delivered with your aView 2 Advance or download at www.ambu.com.

For specific information about specifications of aView 2 Advance and troubleshooting, please consult the IFU.

2. Device overview

The displaying unit consists of the parts listed below

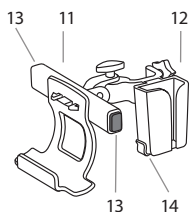
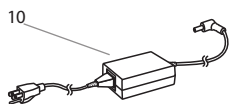
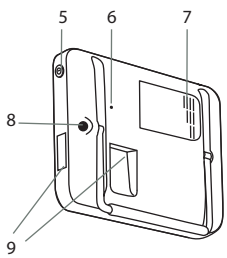
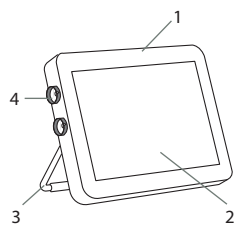

No.	Part	Function
1	Casing	-
2	LCD Touch Screen	Displays the image from the Ambu visualization device and the graphical user interface.
3	Stand	Use the stand to place the displaying unit on a solid surface and to carry the displaying unit while turned OFF.
4	Connector ports for Ambu® visualization devices	Match and align colours and arrows on device plug and the connector port.
5	Power button	Push button for power ON and OFF.
6	Hardware reset button	Reset the displaying unit hardware without impacting stored data.
7	Ventilation holes	Cools hardware during use
8	Power inlet	Power inlet for charging the displaying unit.
9	Input/output connections*	USB, HDMI, SDI, LAN *Wi-Fi available.
10	Power supply	Powers the displaying unit. Power cord with country-specific plug.
11	Bracket	Secures the displaying unit to e.g. an IV pole.
12	Power supply bracket	Secures the placement of the power supply.
13	Release buttons	Releases displaying unit from the bracket.
14	Hook	Storage of visualization device pouches.

3. Setting up the displaying unit

This section explains the physical setup of the displaying unit in its place of operation.



3.1. Turning power ON and OFF

Turn the displaying unit ON:

- Press the **power button**  on the side of the displaying unit.
- A live image is available within seconds after power on, if a visualization device is connected.
- The graphical user interface takes approximately 20 seconds to start up, but a live image is available as soon as the monitor is turned on. If no visualization device is connected, an animation will be shown how to correctly connect a visualization device to the displaying unit.

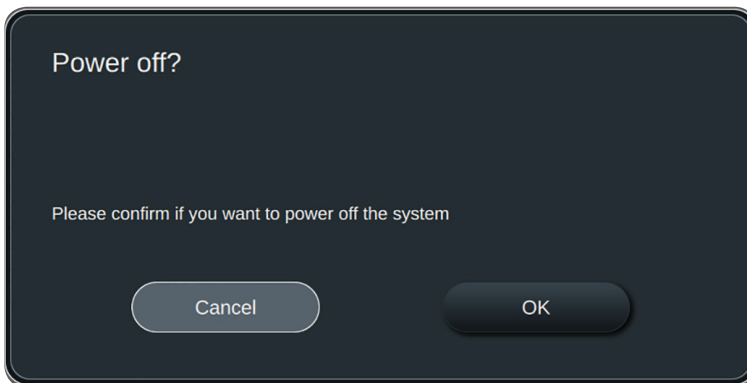

Turn the displaying unit OFF

- Press and release the **power button**  on the side of the displaying unit. When the power button is released a pop-up window will ask you to confirm that the displaying unit should be turned off.
- If the battery level is low, charge the displaying unit (see section 3.6)

3.2. Choosing connector port orientation

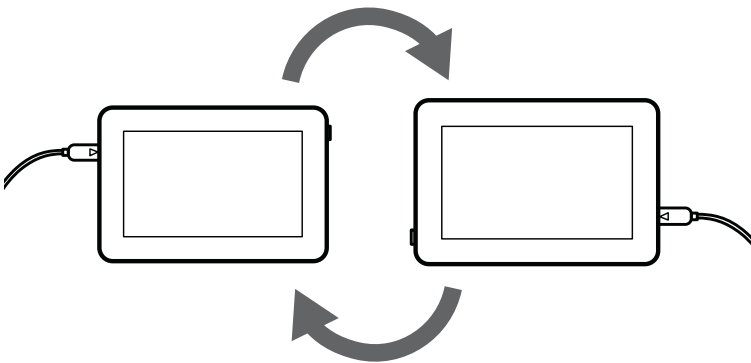

The displaying unit can be rotated 180-degrees to have the connector ports for the visualization devices oriented left or right in your preferred direction depending on the clinical situation. The displaying unit has a built-in sensor which enables the graphical user interface to adapt automatically to its physical orientation. Automatic image rotation can be enabled or disabled under **General settings** (see section 4.2.5)

The displaying unit can be placed on a plane surface with the built-in stand (see section 3.3) or on a pole with the supplied bracket (see section 3.4) in both orientations.

3.3. Placing the displaying unit on a solid surface

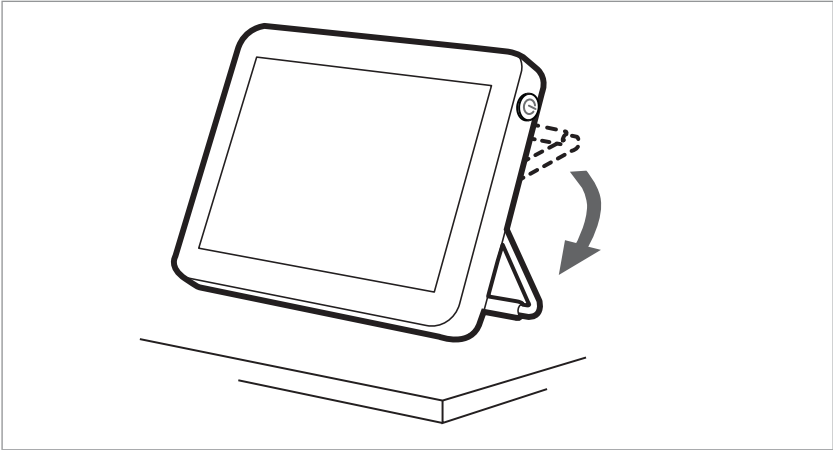

Place the displaying unit on a solid flat surface by folding out the stand on the back of the displaying unit. The stand has multiple settings and can be adjusted to a suitable angle.

3.4. Mounting the displaying unit on a pole

The displaying unit can be mounted on a pole solution, e.g. an IV pole with wheels for easy portability, using the supplied bracket.

NOTE: The bracket is compatible with poles having diameter range of 18-35mm.

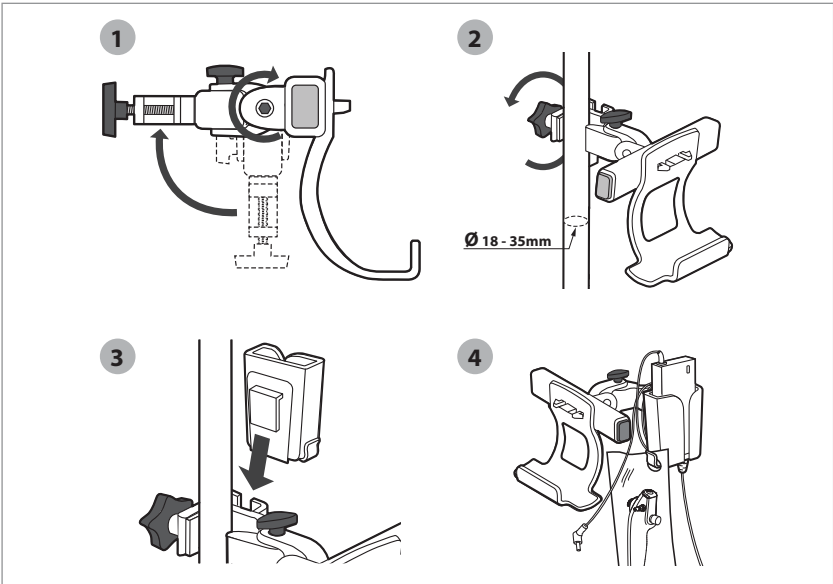

The bracket is mounted on a pole as follows:

- Fold out the bracket and tighten the nut in the middle. **1**
- Mount the bracket on the pole, and ensure the knob is tightened sufficiently. **2**
- Attach the power supply bracket on the bracket and place the power supply in the power supply bracket. **3**
- The hook on the power supply bracket can be used for storing visualization devices in pouches. The power adapter cable can be rolled up on the power supply bracket to improve cable management. **4**

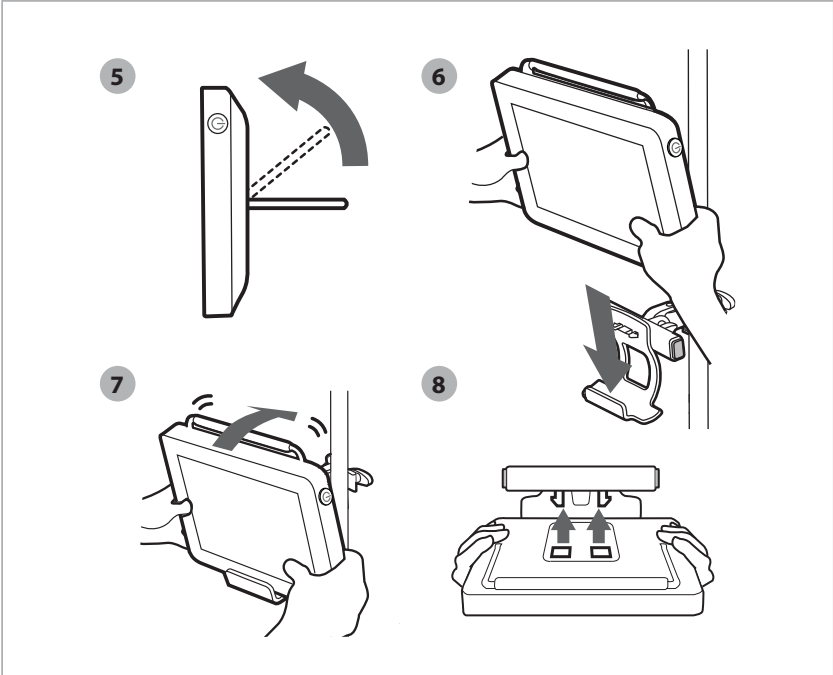

When the bracket is secured on the pole, the displaying unit is mounted on the bracket as follows:

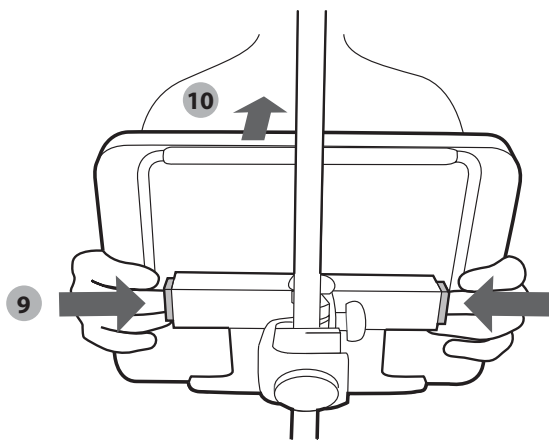

- Fold the Stand upwards against the upper edge of the displaying unit. **5**
- Place the lower edge of the displaying unit in the bracket. The stand must be oriented upwards. **6**
- Push the displaying unit backwards until the lock engages and a click is heard. The hooks on the bracket must engage with the holes on the back of the displaying unit. **7**
- Make sure that the displaying unit is securely placed in the bracket before letting go with your hands. **8**



Unmounting the displaying unit from the bracket:

- Use two hands to hold the displaying unit, while pressing the two grey release buttons on the bracket behind the displaying unit. **9**
- Pull the displaying unit towards yourself. **10**

3.5. Power button light indications

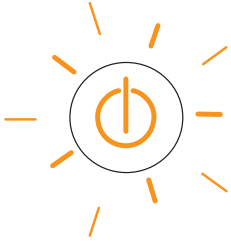
Green Light	Orange Light	Flashing orange
		
Displaying unit is turned ON and battery level is above 40% of full capacity the power button is green.	When the displaying unit is turned ON and the remaining battery level is below 40% of full capacity, the power button turns orange. When the power supply is connected and displaying unit is charging, the power button is orange.	When remaining battery level is below 20% of full capacity, the power button will start blinking to indicate low battery level and charging is recommended. This occurs both if the displaying unit is turned ON or OFF.

3.6. Charging the displaying unit

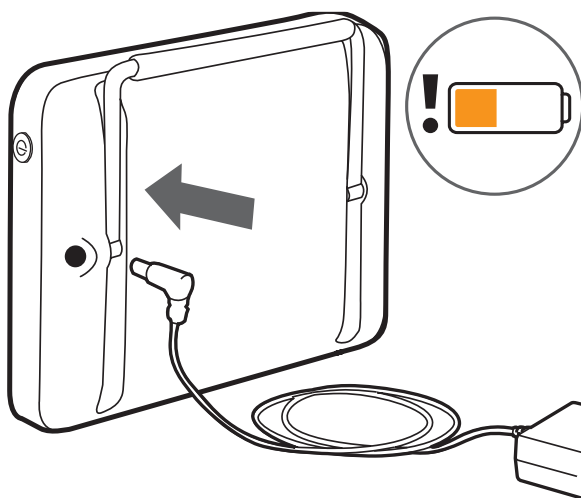

The displaying unit is charged by connecting the supplied power supply as follows:

- Connect the power cord to a power outlet.
- Insert the power plug into the power inlet on the back of the displaying unit.
- The power button turns orange and a lightning ⚡ icon is shown in the battery indicator on the graphical user interface when the displaying unit is charging.

Make sure the power supply is present and working at any time. It is recommended to locate the nearest mains socket before starting a procedure.

3.7. Battery status on the graphical user interface



Green = Battery level > 40%
⚡ = Charging



Orange =
Battery level < 40%

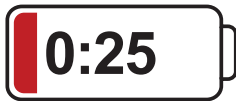

Red =
Battery level < 20%

To check the battery level when the displaying unit is turned ON, check the battery indicator  in the lower left corner of the graphical user interface.

A full charge lasts more than 3 hours when the battery is new. The colour of the battery icon indicates the power level. It is recommended to charge the displaying unit if the battery icon is orange or red.

When battery level changes to orange (< 40%) and red (< 20%) a notification with an enlarged battery icon will appear in the lower left corner of the graphical user. The notification will remain visible when the battery turns red until manually closed.

The battery status is also indicated by the light in the power button. See section 3.5.

3.8. Connecting an Ambu visualization device

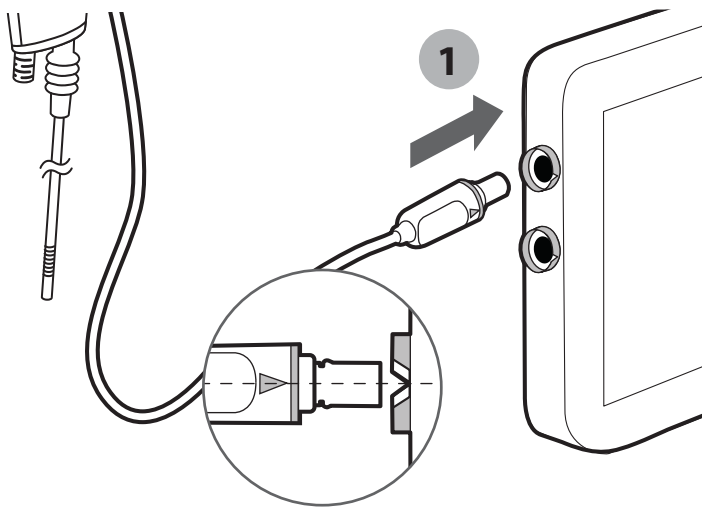

The displaying unit has two identical connector ports for Ambu visualization devices marked with blue rings.

To connect a device:

- Insert the connector plug **1** on the Ambu visualization device cable into one of the connector ports on the displaying unit.
- Ensure that the colours on the connector plug arrow and displaying unit connector ring are matching, and that the arrows are aligned when inserting the plug.

Two visualization devices can be connected at the same time. In this case the displaying unit will show the images side by side (see section 5.1.6 Dual View).

Refer to the IFU for the displaying unit for the list of compatible Ambu visualization devices.

3.9. Connecting to external screens using HDMI or SDI

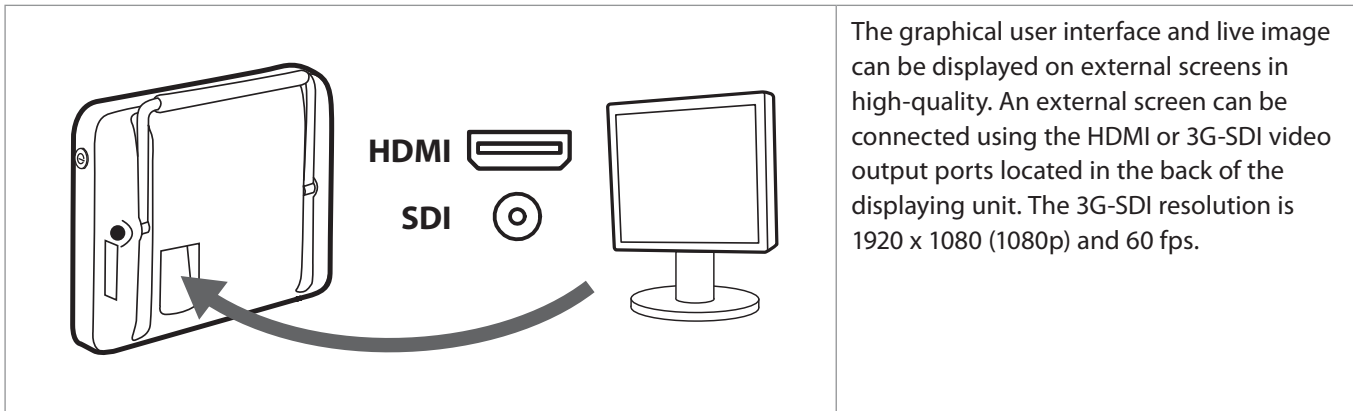

The graphical user interface and live image can be displayed on external screens in high-quality. An external screen can be connected using the HDMI or 3G-SDI video output ports located in the back of the displaying unit. The 3G-SDI resolution is 1920 x 1080 (1080p) and 60 fps.

To connect an external screen:

- Connect an HDMI or SDI cable to the video-in port on the external screen.
- Insert the other end of the HDMI or SDI cable to the corresponding video-out port on the back of the displaying unit.

The graphical user interface of the displaying unit will be shown on the external screen automatically and on both the displaying unit and external screen simultaneously. Both HDMI and SDI can be used simultaneously.

If using SDI, use a 3G-SDI cable for best video quality on you external screen, (ex. RG6/U graded cables)

To avoid risk of electrical shock only connect ancillary equipment, which are approved as medical electrical equipment.

3.10. Connecting to Wi-Fi and local area network (LAN)

The displaying unit contains a Wi-Fi module and ethernet connection to connect the device to a local network. This can be used for exporting recorded imaging data to a PACS (picture archiving and communication system) on the hospital network (see section 5.2.3).

If a network error occurs in your organization, the displaying unit has full functionality while being off-line, except for exporting to PACS. Imaging data is stored in the displaying unit local storage until MANUALLY exported to USB or PACS.

Setting up Wi-Fi and LAN are explained in section 4.2.3

3.11. Connecting USB storage devices

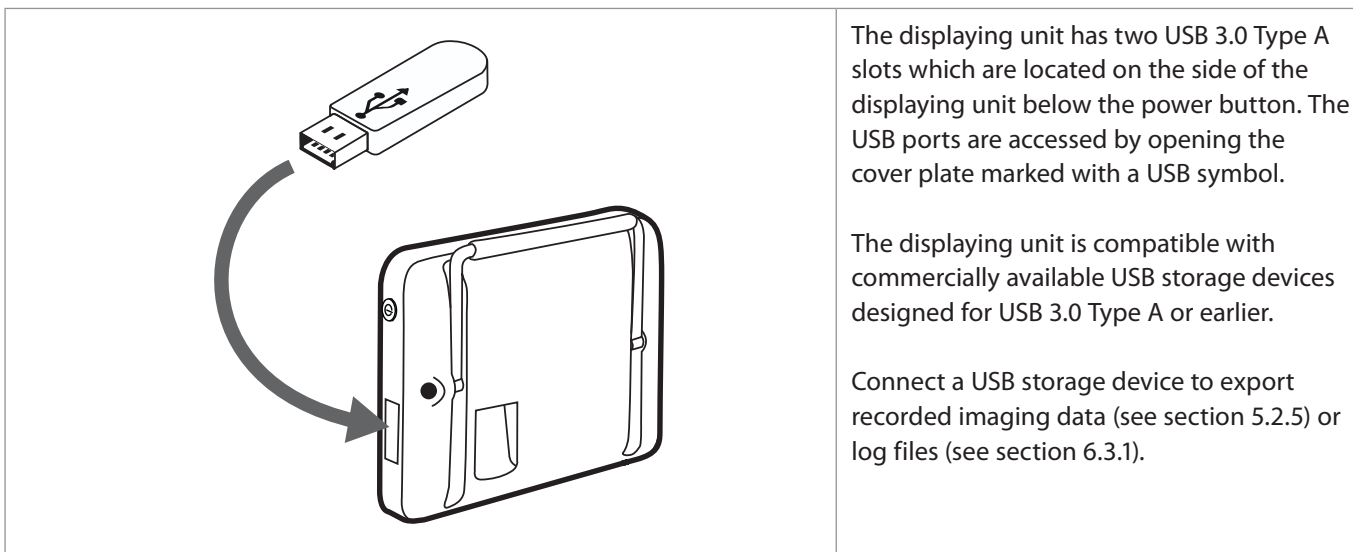

The displaying unit has two USB 3.0 Type A slots which are located on the side of the displaying unit below the power button. The USB ports are accessed by opening the cover plate marked with a USB symbol.

The displaying unit is compatible with commercially available USB storage devices designed for USB 3.0 Type A or earlier.

Connect a USB storage device to export recorded imaging data (see section 5.2.5) or log files (see section 6.3.1).

4. Setting up the displaying unit software

Under the **Settings**  tab, you will find all the menu related to setup of the displaying unit and connectivity. Here you will find the menus: **Setup**, **User Profiles** and **About**.

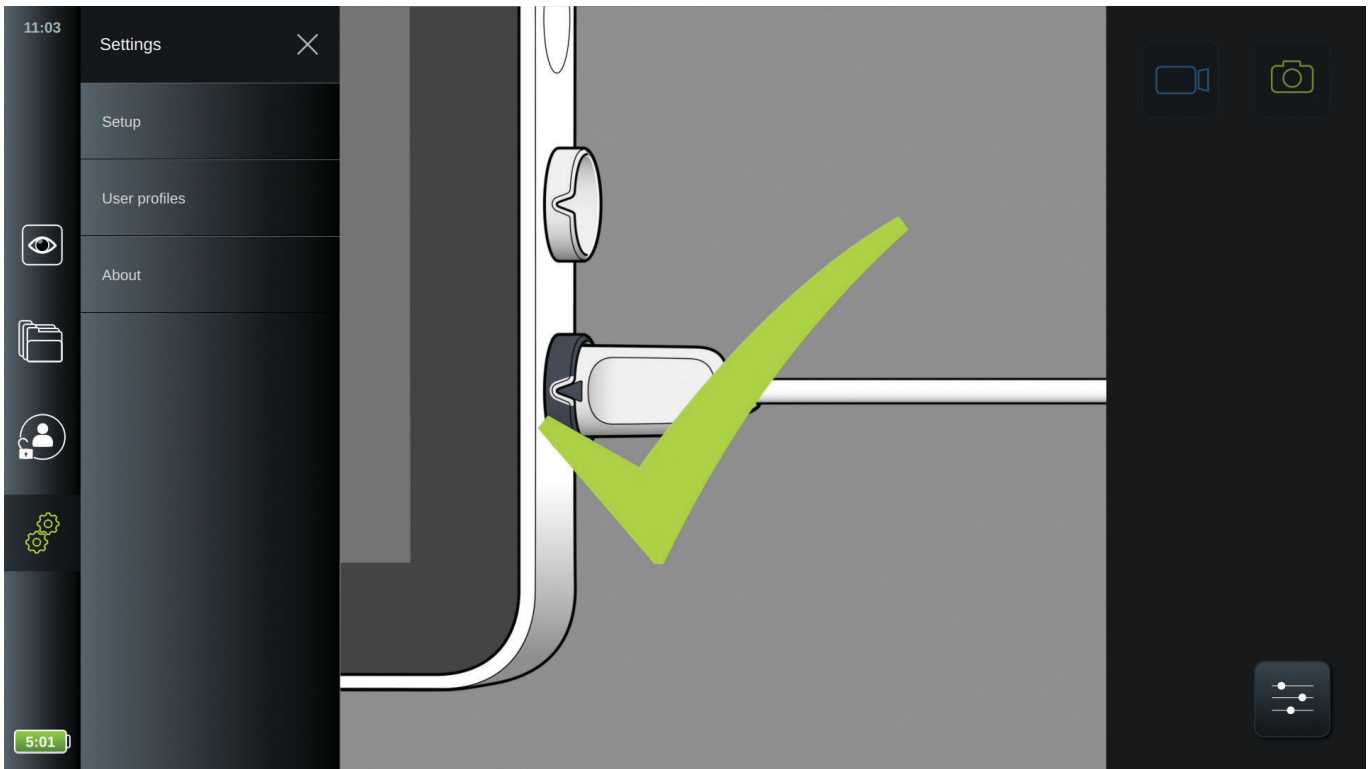

In the **Setup**, menu all system settings, such as system language, date & time and network setup can be selected. In the **User Profiles** menu, you can create or edit user profiles (see section 4.3) . In the **About** menu you will find an overview of device relevant specifications, a menu where you can export log files for troubleshooting, and a menu where you can perform system upgrades (see section 6).

Logging in as **Administrator** is required to get access to the menus under the **Settings**  tab. If you are not logged in, you will only be able to access the **About** menu. See section 4.3 for login guide and information on user account privileges.



4.1. How to log in

As default, login is required to gain the full functionality of the displaying unit. Without logging in, the default user (see section 4.3.1) is active and you only have access to the functions in **Live View** and the **Current Procedure folder**.

For a new displaying unit, the temporary password for the **Administrator** is *AmbuAdmin*. The password must be changed according to your organization's guideline, once the displaying unit is in use.

To log in, press the **Login**  tab in the **tool bar**. The first level menu will appear and show the last user who logged in to the displaying unit. To log in as this user, press the **Enter password** field and type the password.

To log in as different user, press the **arrow**  to open the User Profile menu with a list **5** of all available user accounts on the device. Select the desired user account and press the **Enter password** **6** field and type the password.

Press the Log in button to login. A confirmation pop-up window will appear in the lower left corner if login was successful and the **Login**  icon will change to  showing the device is unlogged.

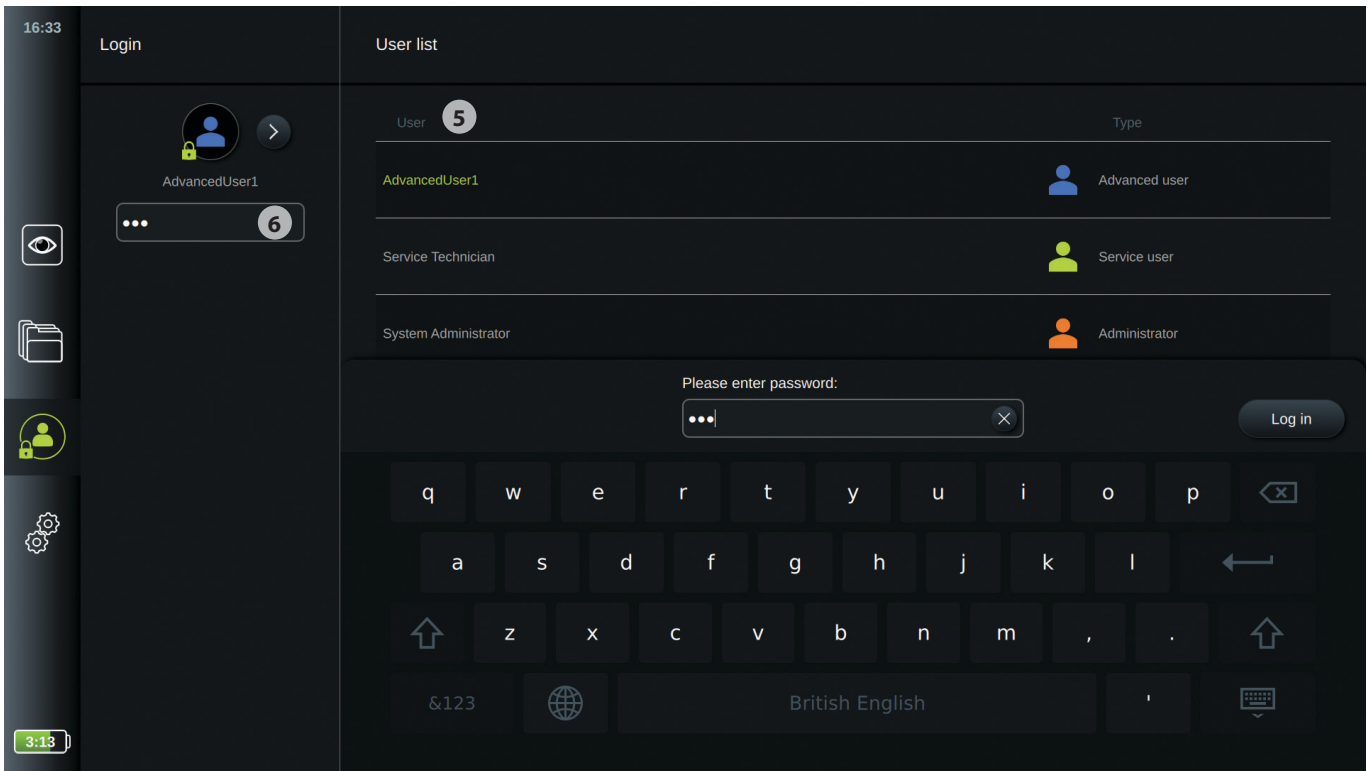

NOTE: Login may be disabled for Advanced users. This is set up in the General Settings explained in section 4.2.5. As default, users are logged out of the device after inactivity for 10 min. These settings can also be changed – see section 4.2.5.

4.2. System setup

In the **Setup** menu under the **Settings**  tab you can access the system setup menus; **Language, Date and time, Network setup, DICOM setup** and **General settings**.

Please note that your organization is responsible for the following areas, which should be implemented according to your local policy and schedule:

- Network setup
- Ensuring availability and confidentiality of network
- Ensuring confidentiality and integrity of physical devices
- Management of the displaying unit user profiles
- Maintenance of user passwords
- Monitoring and audit of the Ambu Imaging System
- Complete data erase at disposal of the displaying unit

A complete Ambu Imaging System is configured as illustrated in the figure below. The various connections are described in more detail in the following sections.

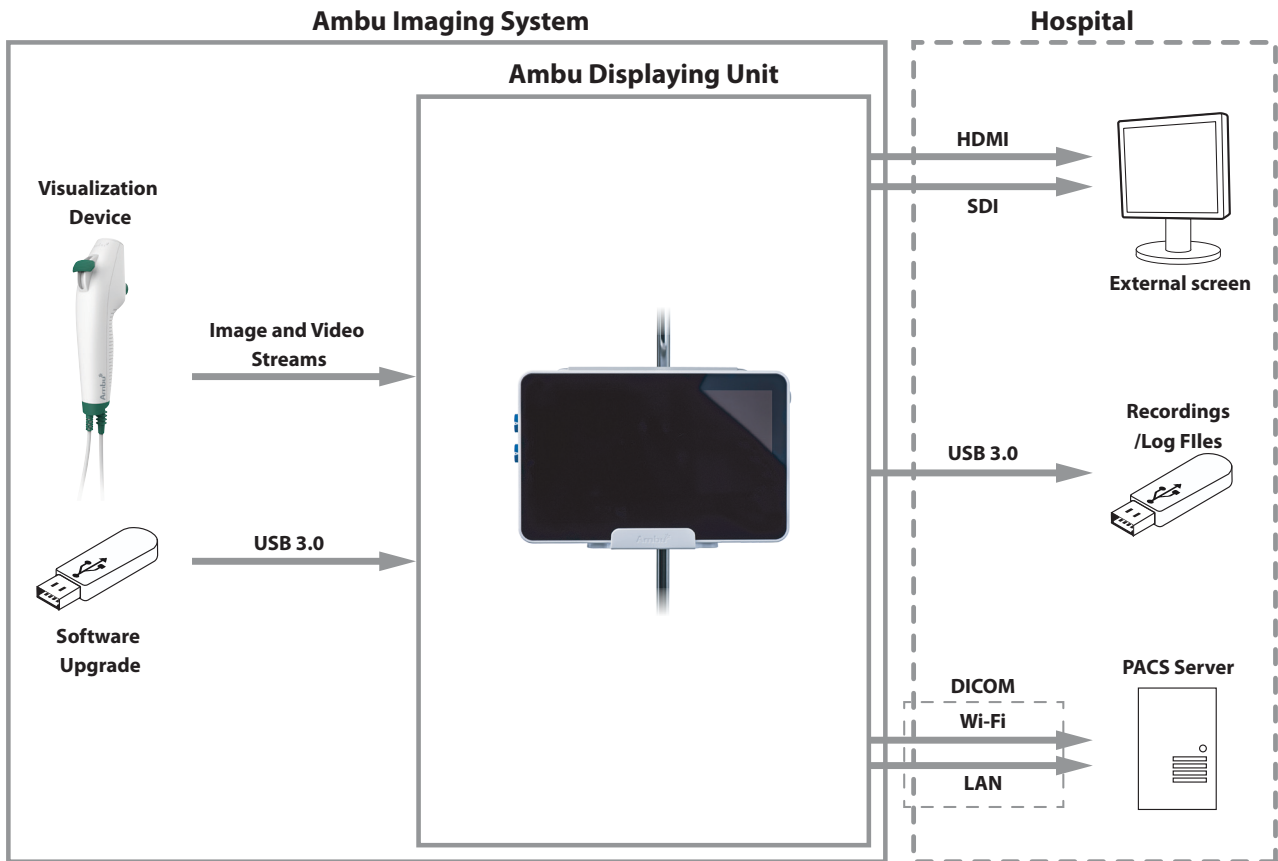

4.2.1. System language

In **Language** under the **Setup** menu the language preference for the graphical user interface is selected. By default, the language setting of the displaying unit is English. When setting up the displaying unit, select your language preference.

- Press the **Settings**  tab in the tool bar on the right
- Press **Setup** and the **Language** **1** menu will be open
- Open the **System language** **2** drop-down menu and select language from the list.

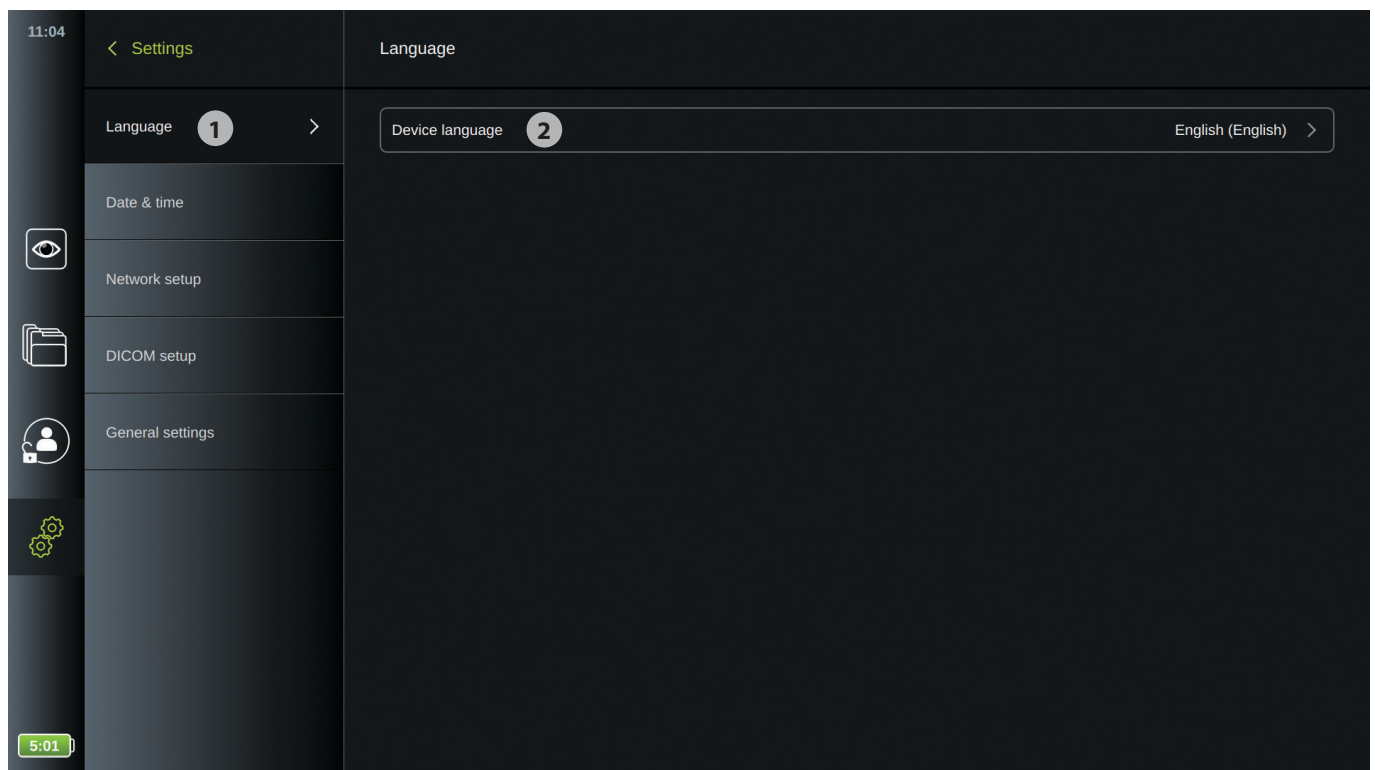

NOTE: The language will change immediately when a new language is chosen. The default language is English.

4.2.2. Date and Time

In **Date & Time** under the **Setup** menu the local date and time, where the displaying unit is used, can be selected.

- Press the **Settings**  tab in the tool bar on the right
- Press **Setup** and press **Date & Time** **3**
- Open the **Time zone** **4** drop-down menu and select time zone from the list. The time zone setting is used to correct daylight savings automatically. It is important to choose the correct time zone so that correct daylight savings can be updated automatically
- Use the **Set time** **5** wheel to set the current time
- Select the current date in the **Date** **6** calendar

The settings are activated as soon as they are chosen.

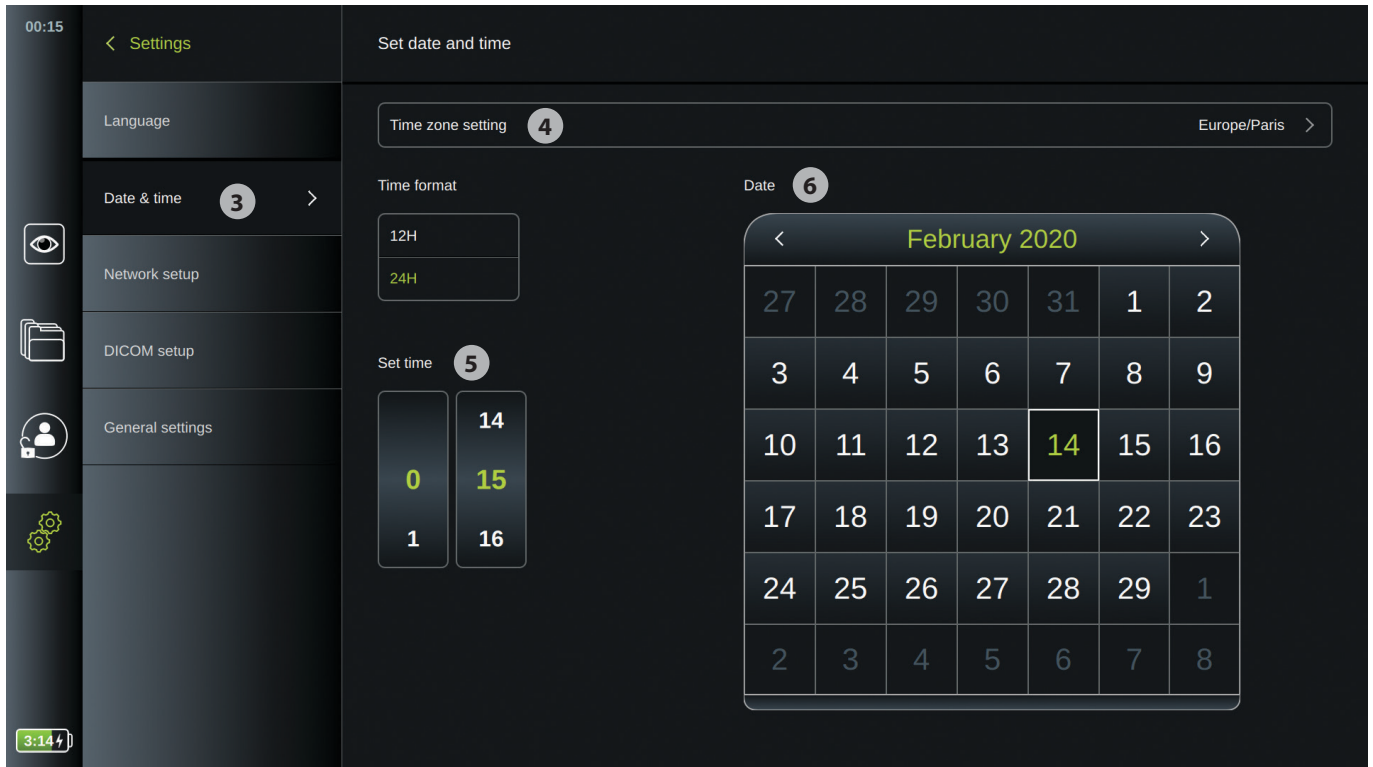

4.2.3. Network setup

In **Network Setup** under the **Setup** menu you can setup connection to Wi-Fi and local area network (LAN).

NOTE: Always use a secure network when handling images and patient data. See technical details about the configuration of the LAN in Appendix 3.

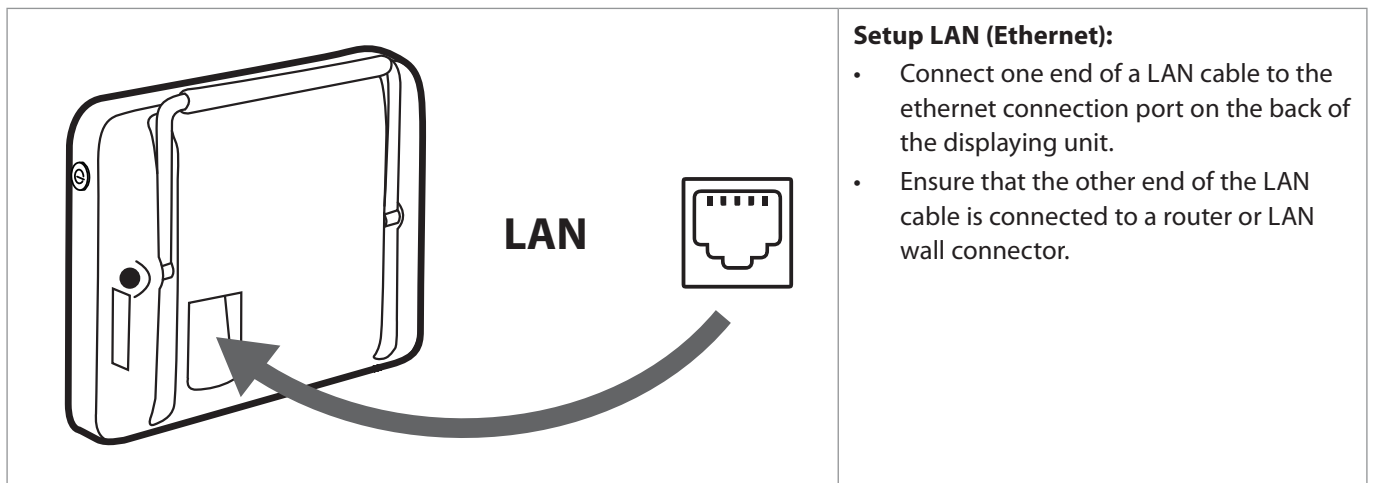

Setup Wi-Fi:

- Press the **Settings**  tab in the tool bar on the right
- Press **Setup** and press **Network setup**

See technical details about the configuration of Wi-Fi in Appendix 3.

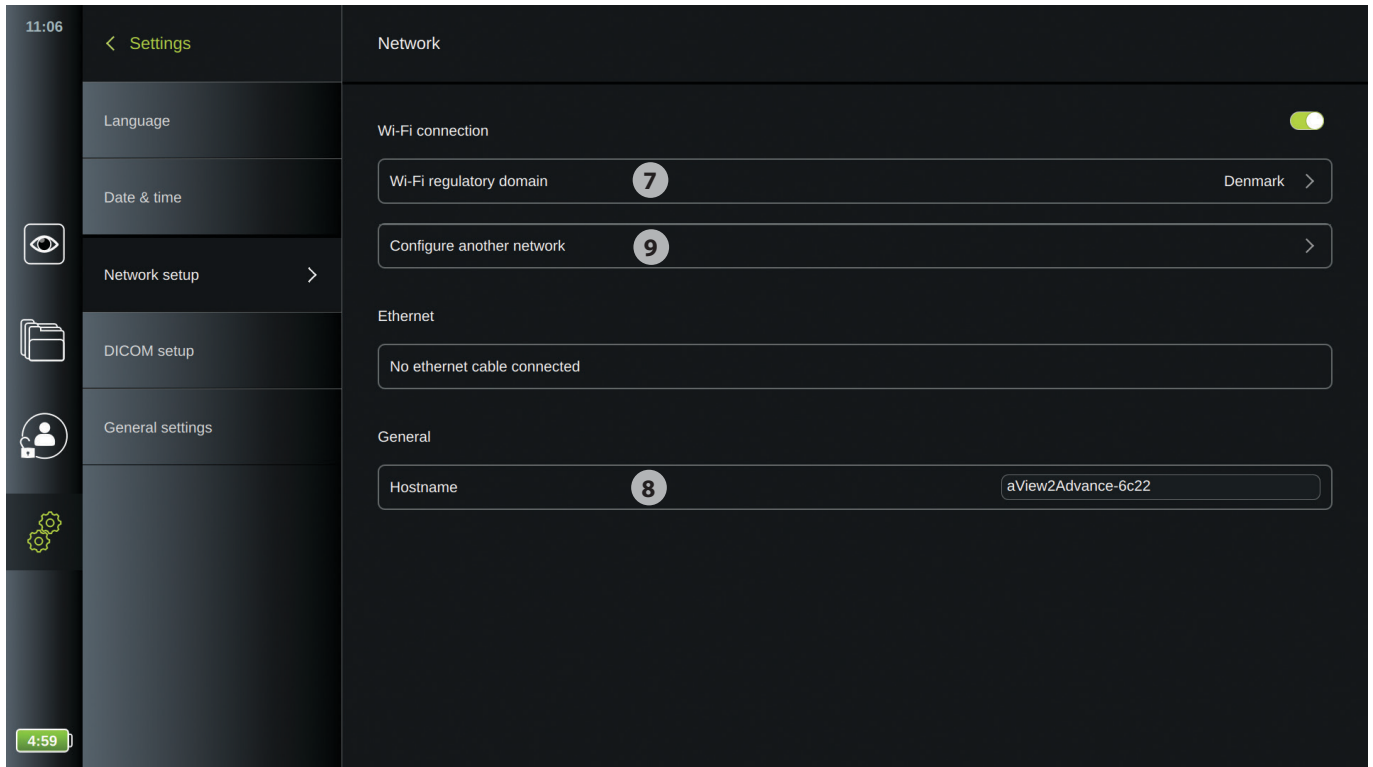

- Open the **Wi-Fi Regulatory Domain** **7** drop-down menu and select your region from the list.
- After selecting your region an ON/OFF slider will appear. Make sure that the ON/OFF slider is enabled (green) so the Wi-Fi is turned on. Press the ON/OFF  slider once to change between ON and OFF.
- In the **General** menu you can set up the static/fixed **Hostname** **8** of the device. This is used if it is required to have a fixed name by which the device is recognized on the network, similar to a static IP address. The **Hostname** can be between 1 and 63 characters (excl. dot "." separator) in the format of xxx.xxx.xxx with dots separating e.g. domain names. The following characters are allowed: a - z (lowercase letters), A - Z (uppercase letters), 0 - 9 (numbers), "-" (hyphen; not allowed as the first and last character in the hostname).
- Press **Configure another network** **9** and a list of available networks is shown. If a network is already connected it will be listed under **Currently Selected Network**, and otherwise the same field will say **No network selected** **10**.

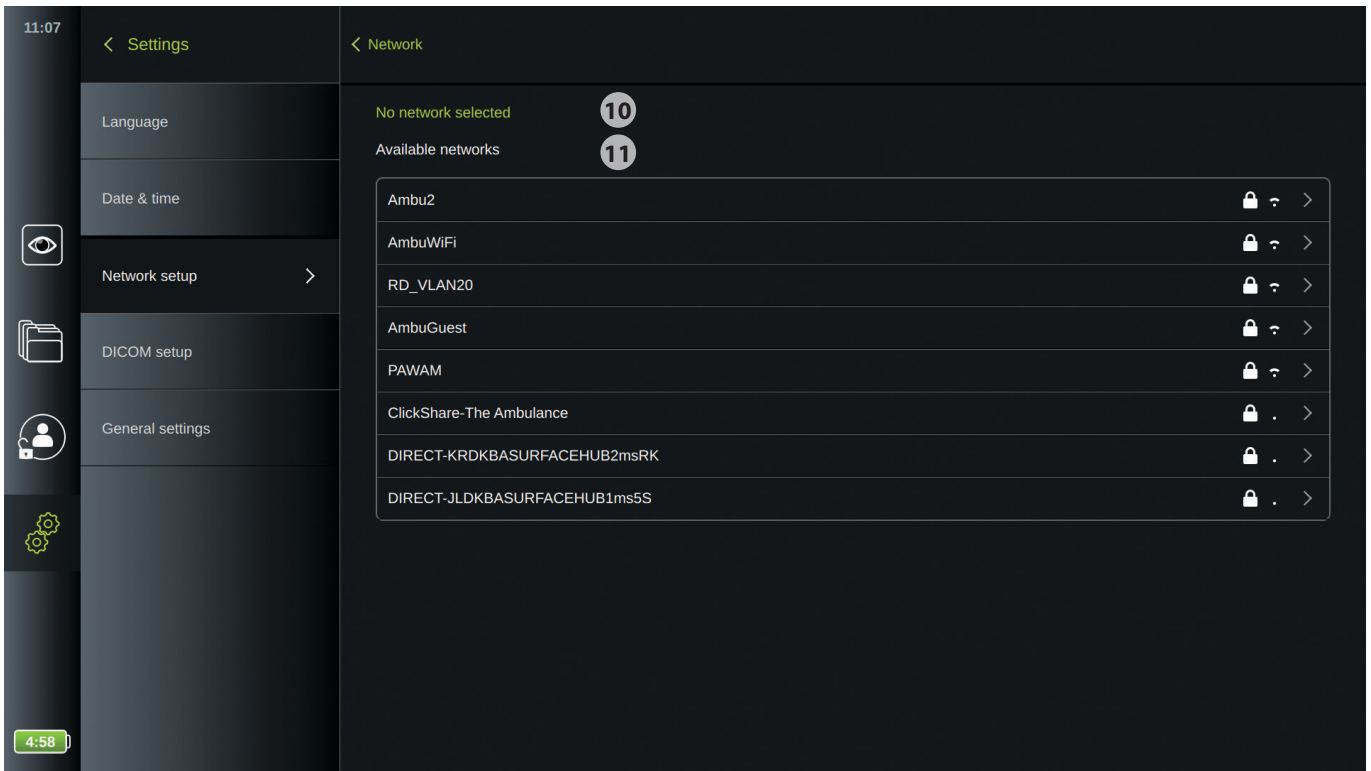



Connecting to a new network :

- Choose a new network from the list **Available networks** **11**
- Type the **password** **12** for the selected network, press **OK** and press **Connect**. IP-address will be assigned automatically.

NOTE: Wi-Fi networks which require redirection to a login webpage for entering user name and password are not supported on the displaying units.

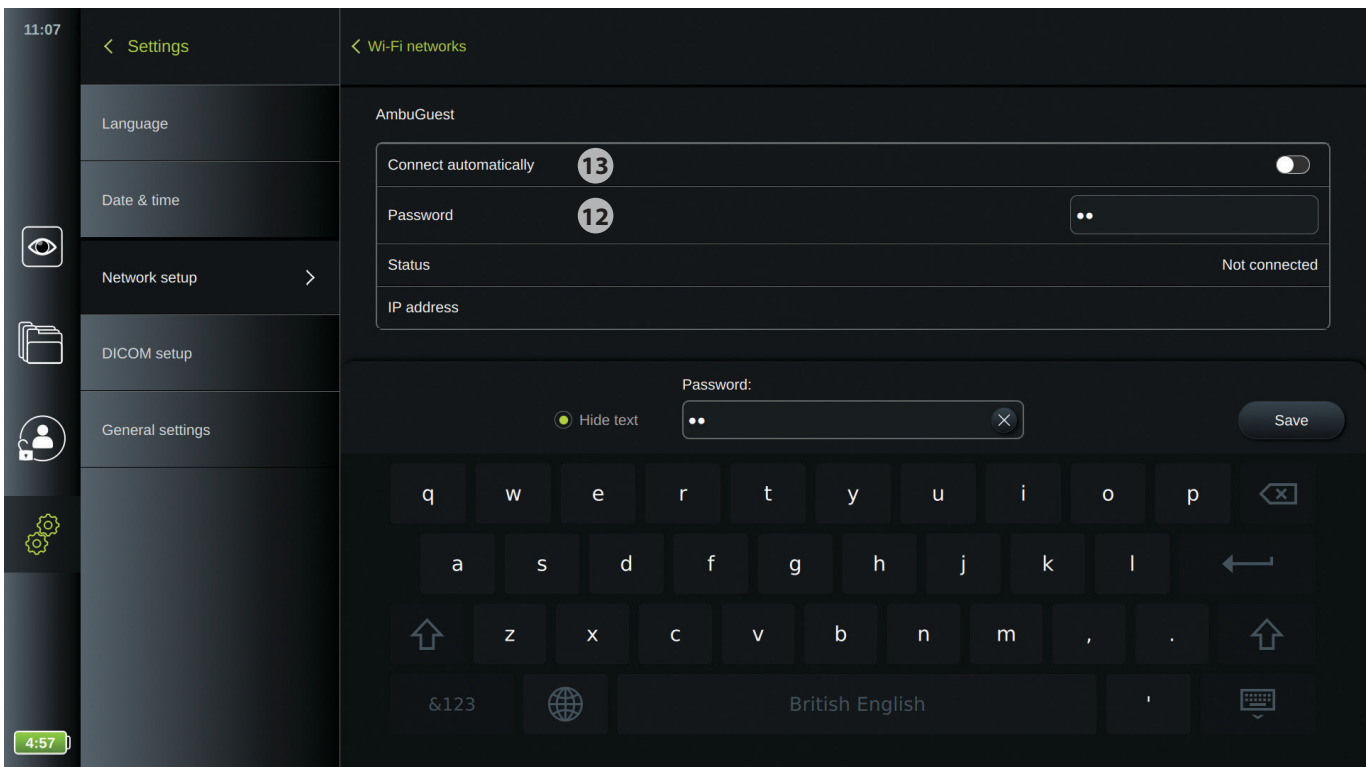
You can choose automatic connection to this specific network by pressing the ON/OFF by **Connect automatically** **13**. The displaying unit will then automatically connect to this network, when it is recognized.



When Wi-Fi is connected a Wi-Fi symbol  will be shown above the battery level indicator in the tool bar menu to the left on the screen.

Disconnecting from network:

Press the connected network and then press the **Disconnect 14** button.

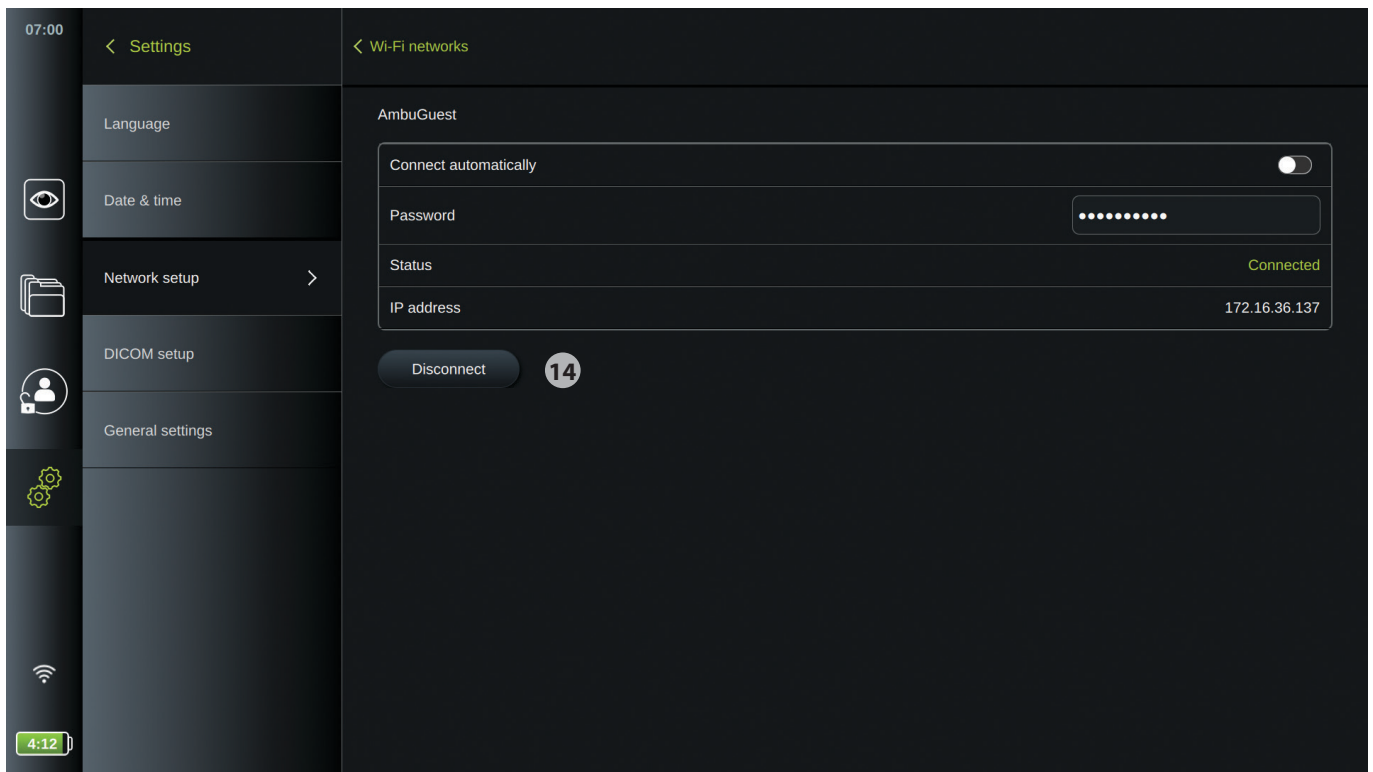

4.2.4. PACS setup

In **DICOM Setup** under the **Setup** menu, you can configure connection to a PACS (picture archiving and communication system) to be able to transfer recorded images and video in DICOM (Digital Imaging and Communications in Medicine) format over the Wi-Fi or LAN network.

To set up a PACS, you may need to involve your IT department or PACS manager in the department or hospital. See technical details about the configuration of PACS in Appendix 3.

To access the DICOM setup page (login as Administrator):

- Press the **Settings**  tab in the tool bar on the left
- Press **Setup**, and press **DICOM setup**

An overview of already configured PACS servers is shown, if any.

- Choose **Device AE (Application Entity) title** to enter the name of the displaying unit. The default name is **AmbuMon**. This name will allow the PACS to recognize the displaying unit. Press the name field and type to change the name. The name can maximum be 16 characters.
- Choose if the **Station name** should be assigned as the device "serial number" or a "custom name" which is entered manually. The Station name is an optional attribute in DICOM used by PACS to identify the displaying unit.

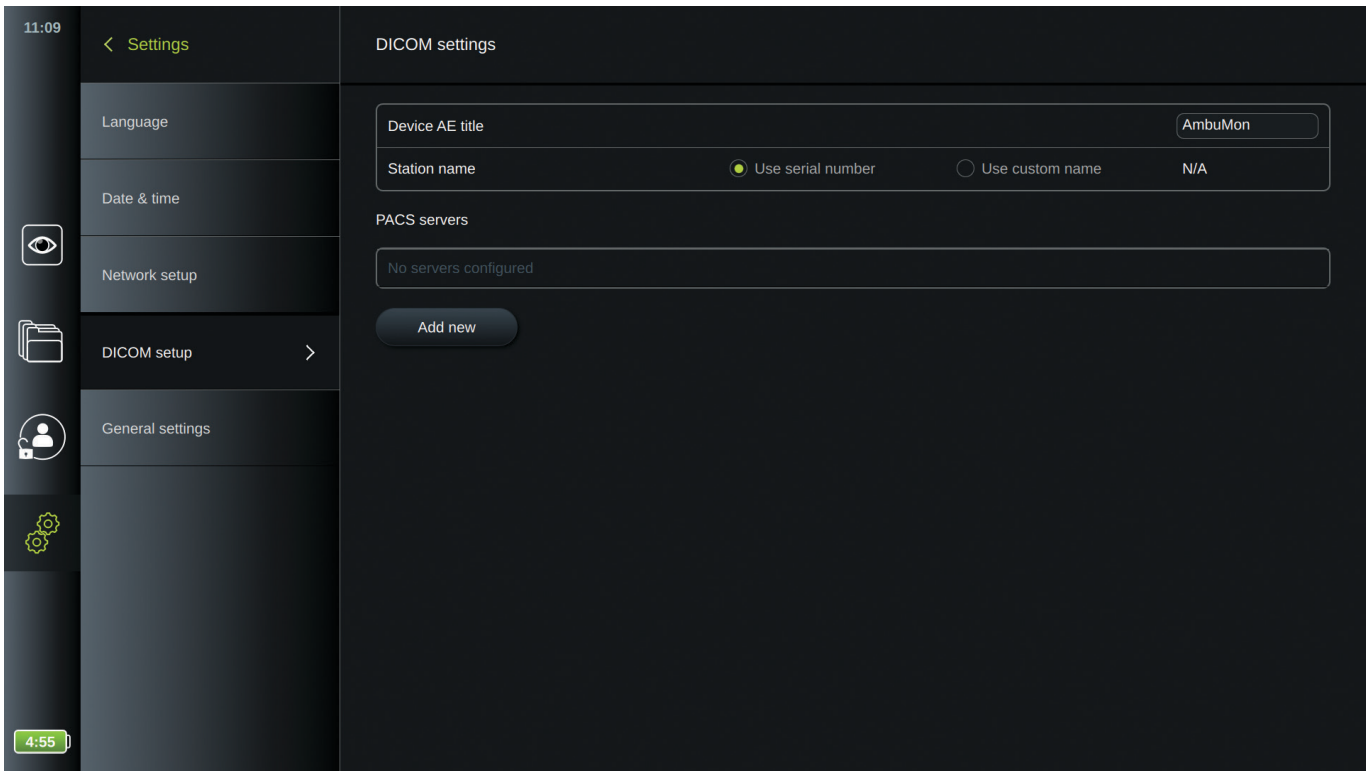

Set up connection to PACS server:

- Press **Add new**, and the **Configure new PACS** server menu will appear.
- Press the first field (PACS name) **15** and type to add the details
- Use the **arrow >** **16** to go to the next field

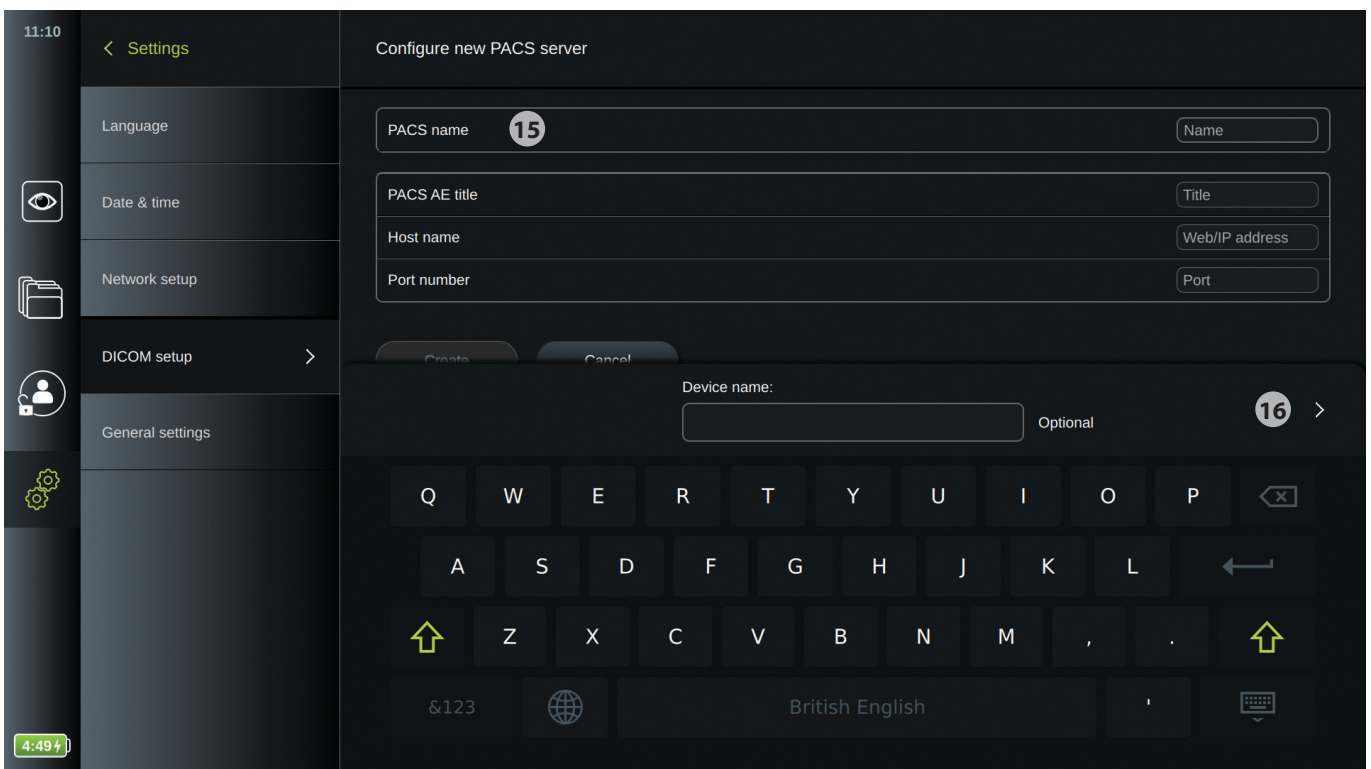



The table below shows the information that must be filled out. Please contact your hospital IT and/or department PACS manager if you do not have this information available.

Information needed	Explanation
PACS name	This is the name of the PACS. Used in the export menu to select the PACS when transferring images and videos.
PACS AE Title	PACS Application Entity Title The AE Title is maximum 16 characters
Host name	IP-address, MAC address or full web address for the PACS
Port number	Network port no. for the PACS

When all the fields have been filled out press **Create** to save the PACS configuration. In the following window you can test the PACS connectivity by pressing the "Test connection" button. If the the test fails, check the entered information is correct and try again. For further assistance please contact your hospital PACS manager.

4.2.5. General settings

In **General Settings** under the **Setup** menu, you can enable and disable the **USB connector ports**, the **Live View 180-degrees rotation** function, **access to archive without login** as well as set **user inactivity logout** time.

- Press the **Settings**  tab in the tool bar on the left of the Live View screen
- Press **Setup** and press the **General Settings 17**
- Press the ON/OFF  sliders once to enable or disable functions

USB input is used to enable and disable the USB ports. When USB input is **disabled** (slider set to OFF), the USB ports are blocked and cannot be used to export recorded image files or perform software upgrades.

In **Live view controls**, the rotation of the graphical user interface can be locked so it does not rotate when the displaying unit is physically rotated to have connectors to the left or right (see section 3.2). You can lock the orientation of the graphical user interface to your preference, by disabling the automatic rotation when the interface is in your preferred position.

The **Access archive without login** function is used to enable and disable access to the archive without having to login. When activated, please note that the Archive is no longer password protected. The Default User is provided Advanced User privileges to access previous procedures and view, delete and export files. Please see section 4.3.1 for further information on user types. In factory default this feature is disabled.

In the **User inactive logout** section, you set the time when the logged in user is automatically logged out if the displaying unit has been inactive for the selected time. The displaying unit is defined as inactive when no visualization device is connected and no functions on the graphical user interface are activated. You may choose the user should *never* be logged out while the displaying unit is turned on. Users are always logged out when the displaying unit is powered off, unless **Access archive without login** is enabled.

In **Enable 180 image rotation in Live View**, the 180 degrees rotation feature of the live image can be disabled. The 180 degrees rotation function is available in the **Image Adjustment** menu in the **Live View** screen (see section 5.1.2). When the selector is activated the function is disabled and made invisible in the **Image Adjustment** menu.

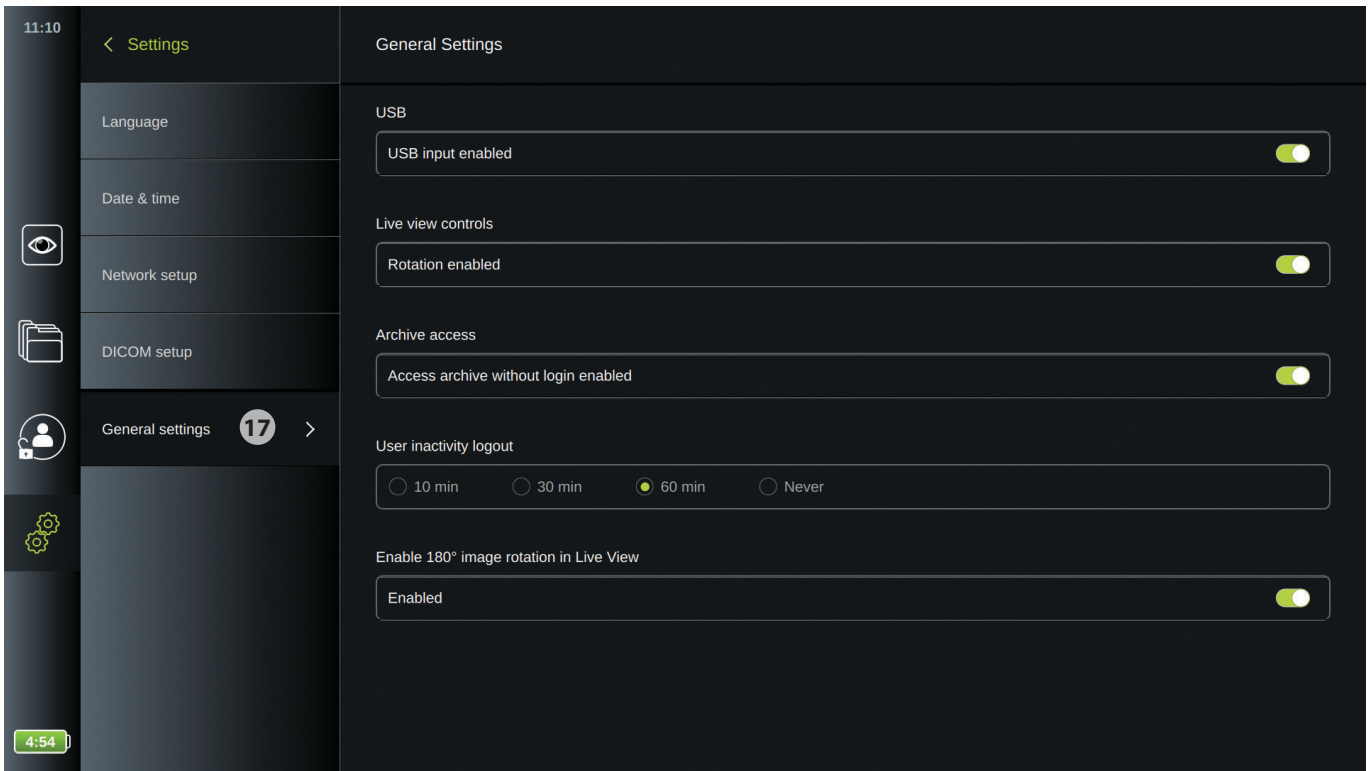

4.3. User profiles

In the **User Profiles** menu, you can create new or edit existing user profiles. To access this menu, you must be logged in as **Administrator**. See sections below for login and information on user account privileges.

4.3.1. User types

There are four types of users in the displaying unit: **Default user**, **Advanced user** (blue), the **Administrator** (orange) and the **Service user** (green). These profiles have different degrees of system access and privileges as shown in the table below.

User Types and System Access					
User Type		Default User	Advanced User	Admin User	Service User
		Instant access without login	Daily operation	Administrator with full access	Service related tasks
Function Access					
	Login Required		X	X	X
	Live View	X	X	X	X
	Video Recording	X	X	X	X
	Snapshot	X	X	X	X
	Current Procedure	X	X	X	X
	Image Adjustments	X	X	X	X
	Archive	X*	X	X	
	Settings			X	X**

* Access to Archive without log in can be enabled by Administrator in Settings.

**Service User does not have permission to add and change user profiles.

Advanced User profile gives daily users the privileges to access the **Archive**  and to export recorded files to PACS via DICOM. It is recommended to create at least one Advanced user profile (e.g. department login), or individual Advanced user profiles for each user of the displaying unit.

It is not possible to create additional Administrator and Service User profiles. The Administrator has privileges to change settings for all users. All users have privileges to change their own passwords.

4.3.2. Create and edit user profiles

To access the User profiles menu:

- Press the **Settings**  tab in the **tool bar** on the left
- Press **User Profiles**

Create a new Advanced User profile:

- Press **Add user** **1**
- Enter User name, Password and Repeat password **2**. Use the **arrows >** to go to the next field. Password must be at least 8 characters. For information on password requirements, please see section 4.3.3.
- Press the **Save**  button

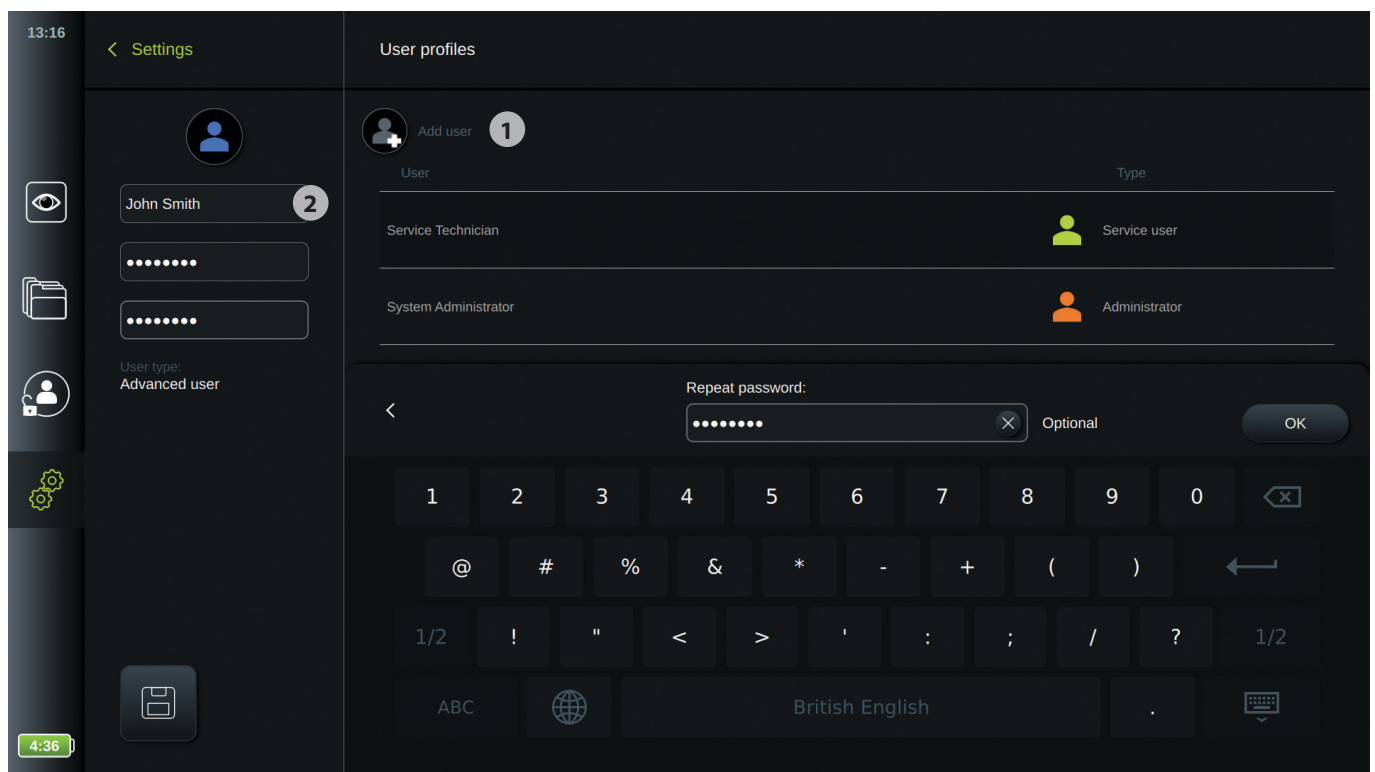

Edit an existing Advanced User profile:

- Press a user profile from the **User list** **3** to select it. Now, the **User name**, **User type**, **Created** time is shown in the left side of the screen
- Press **edit** 

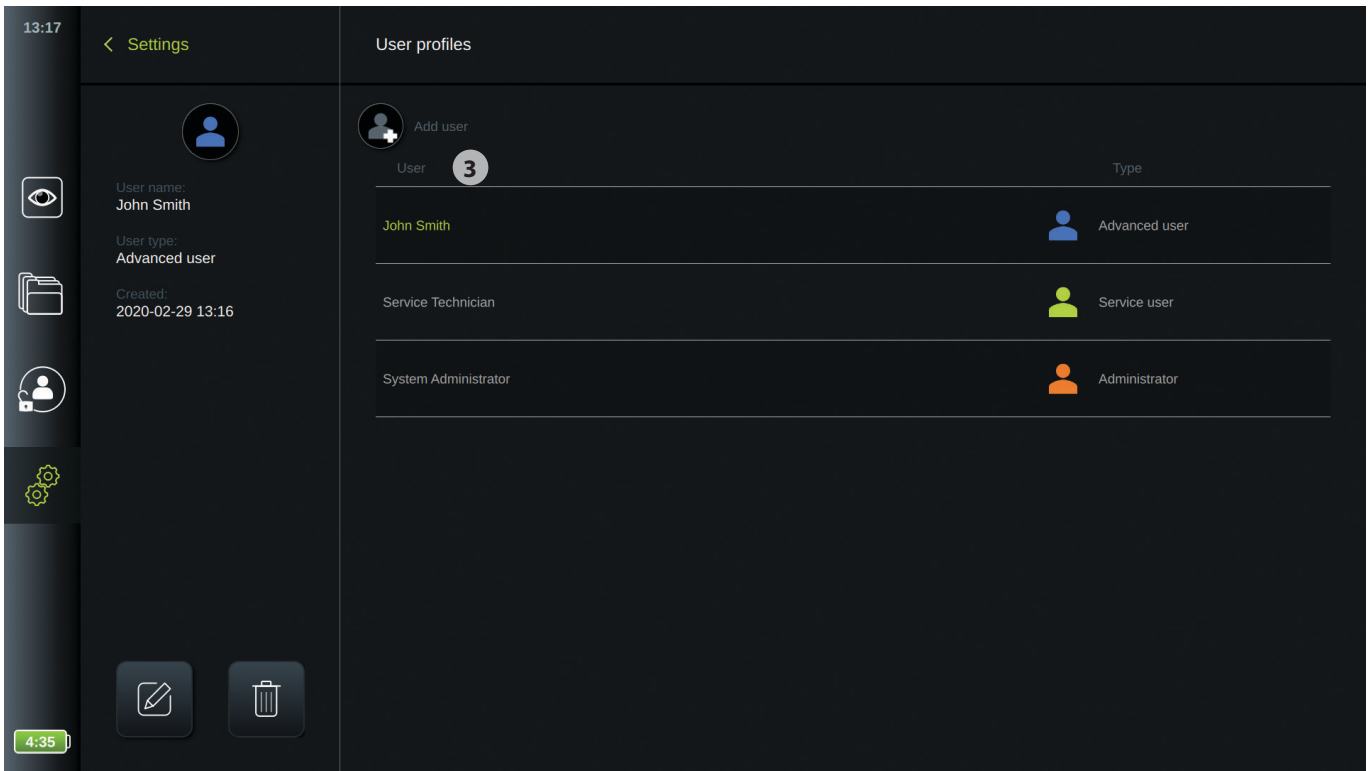

- Type a new name and/or select a new password and repeating the new password **4**
- Press the **Save**  button
- Press **OK** in the pop-up window to confirm the change.

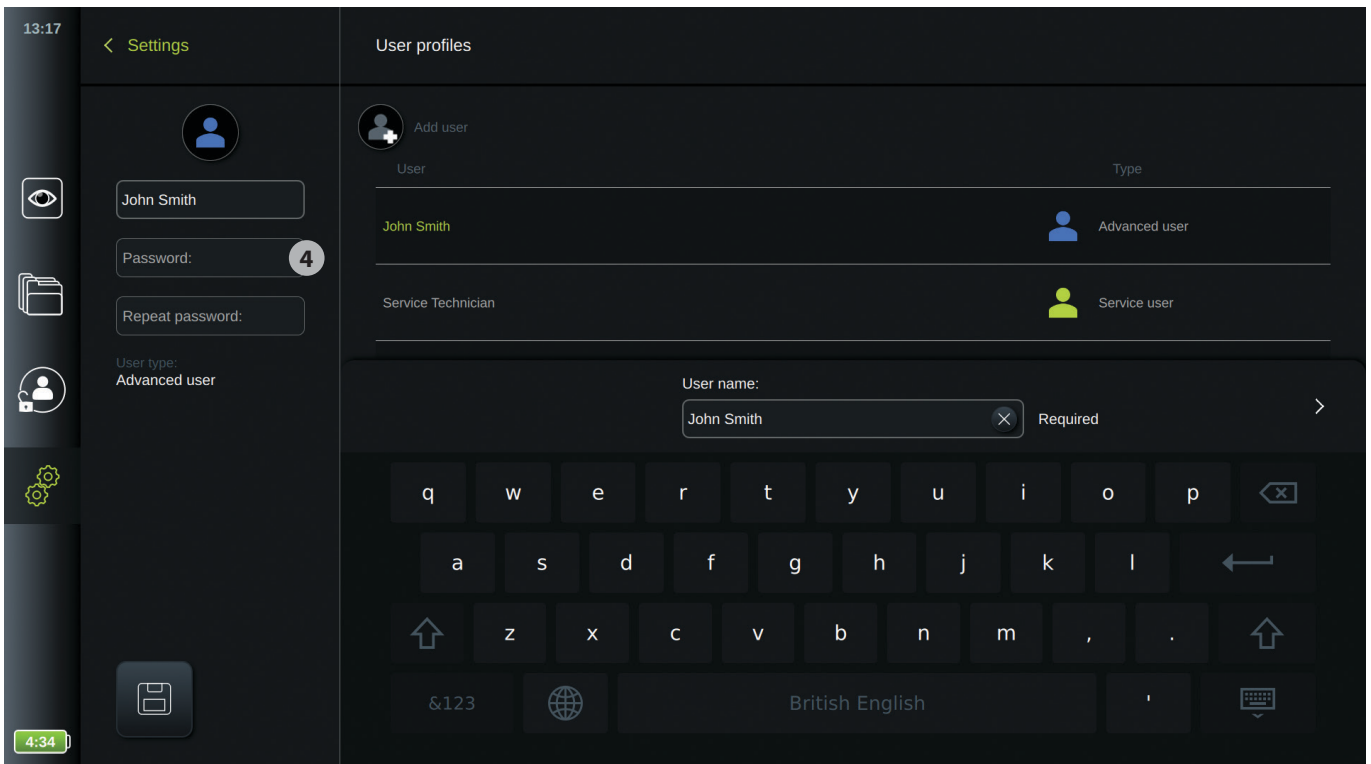

4.3.3. Password requirement

Passwords are required to be at least 8 characters. Any character is allowed. It is recommended to use a combination of capital and small letter, numbers and symbols to enhance password protection.





5. Operating the displaying unit

This section describes the functions in the user interface of the displaying unit. It is a prerequisite that the system is turned ON and an Ambu visualization device is connected to one of the two connector ports, as described in section 3.1 and section 3.8 respectively.

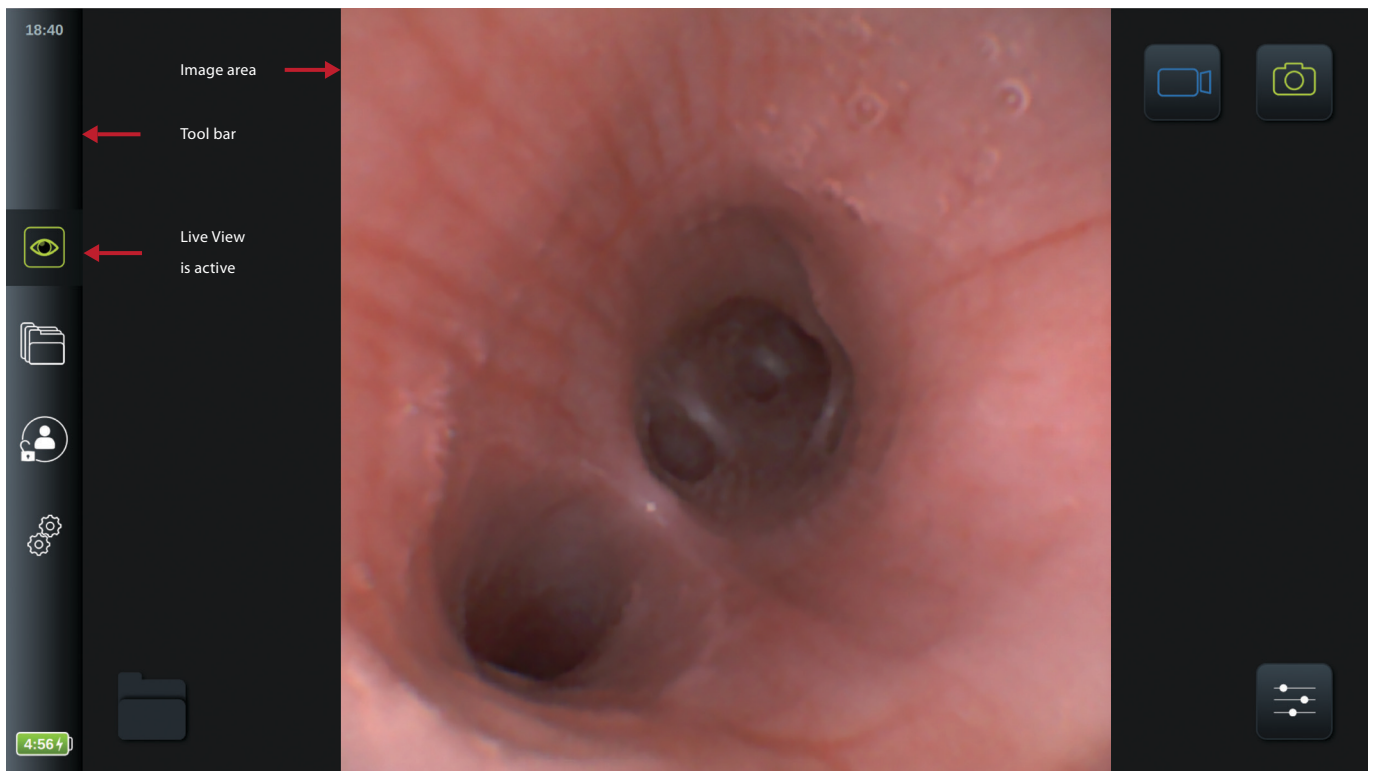





5.1. Live View (main screen)



When the displaying unit is turned ON and the user interface has loaded after approximately 20 sec, the **Live View**  menu appears. If an Ambu visualization device is not connected, an animation is playing in the live image area showing how to correctly connect an Ambu visualization device. If a visualization device is connected, the live image is available as soon as the displaying unit is turned on. Even if a network error or other problems in the system occur, the live view will still be available making it possible to use the displaying unit for clinical purposes.



The toolbar is always located in the left side of the screen. It contains the **Live View** , **Archive** , **Login**  and **Settings**  tabs. The active tab in the toolbar is always highlighted in green colour. The toolbar is always visible when sub menus are opened. It is always possible to go back to Live View with one click on the **Live View tab** .

The icons in the Live View are described in the table below. The functions, except battery icon, are explained in the following sections.

Explanation of icons in Live View 		
Icon	Name	Function
	Live View	This tab shows the live image from the connected Ambu visualization device.
	Video Recording	Press the blue Video Recording button to start recording video during the procedure. Press again to stop recording.
	Snapshot	Press the green Snapshot button to take a still image during the procedure or video recording.
	Archive	Access recordings. Manage and export files. Login may be required.
	Login	Login is required to access settings, archive and export files with DICOM.
	Settings	Access system settings. Login as administrator is required to gain access.

	Battery	The time stamp indicates the time left on the battery while using a visualization device.
	Current Procedure	View videos and snapshots recorded in the current procedure.
	Image Adjustments	Adjust colour, contrast, sharpness, brightness, and image orientation (180 degrees rotation).

When one of the other tabs (Archive, Login or Settings) in the tool bar is activated a first level menu opens extending over the black area left of the live image area. If no action is taken within 5 seconds, the first level menu will close again. If user selects any of the sub-menus, a new menu will open that covers the live image.

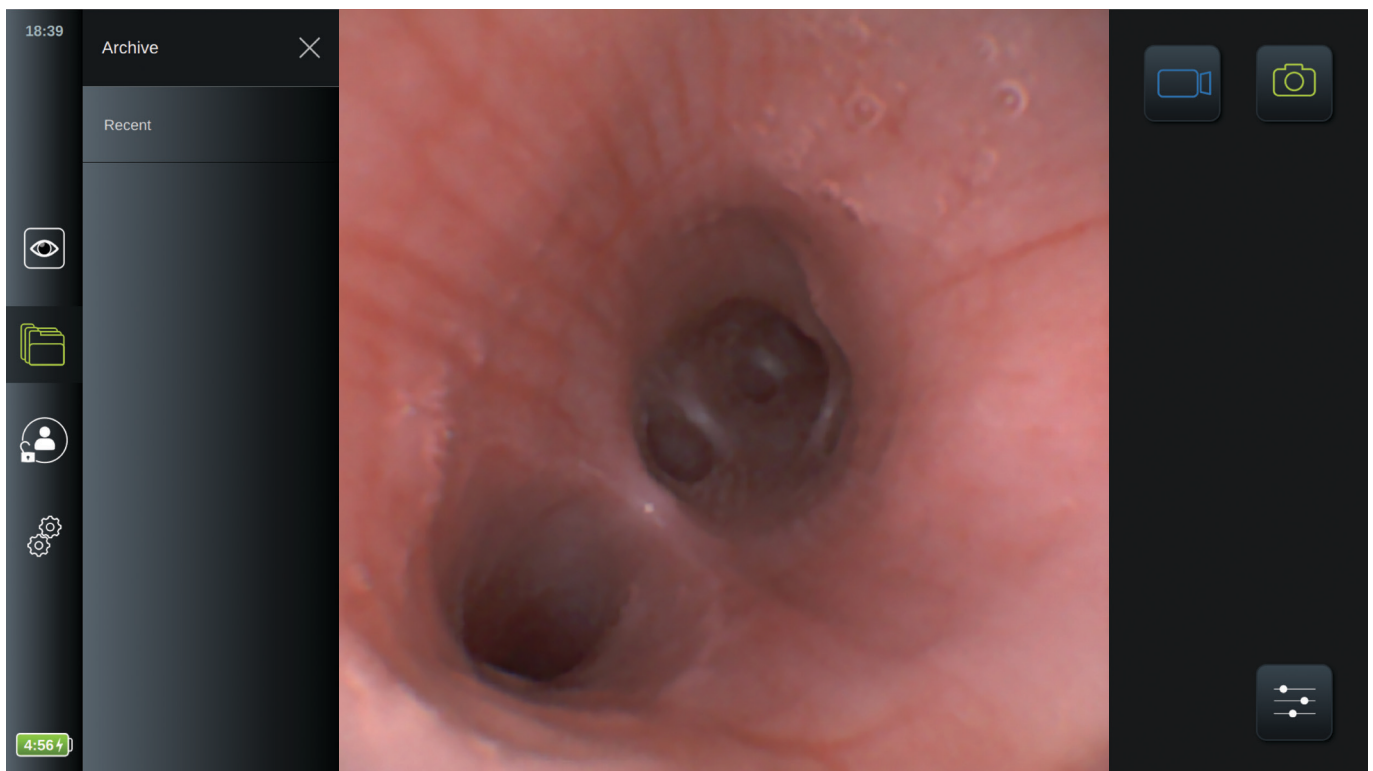

5.1.1. Adjusting live image appearance

In the Image Adjustment  menu, you can change the **Colour**, **Contrast** and **Sharpness** in the live image as well as the **Brightness** (backlight) of the LCD screen. An Image Rotation function  is also available and explained in section 5.1.2.

To change the image parameters:

- Press the **Image Adjustment**  icon to open the menu.
- Adjust the image settings. Either press the icon at each end of the slider bar or drag the slider left/right on the bar.

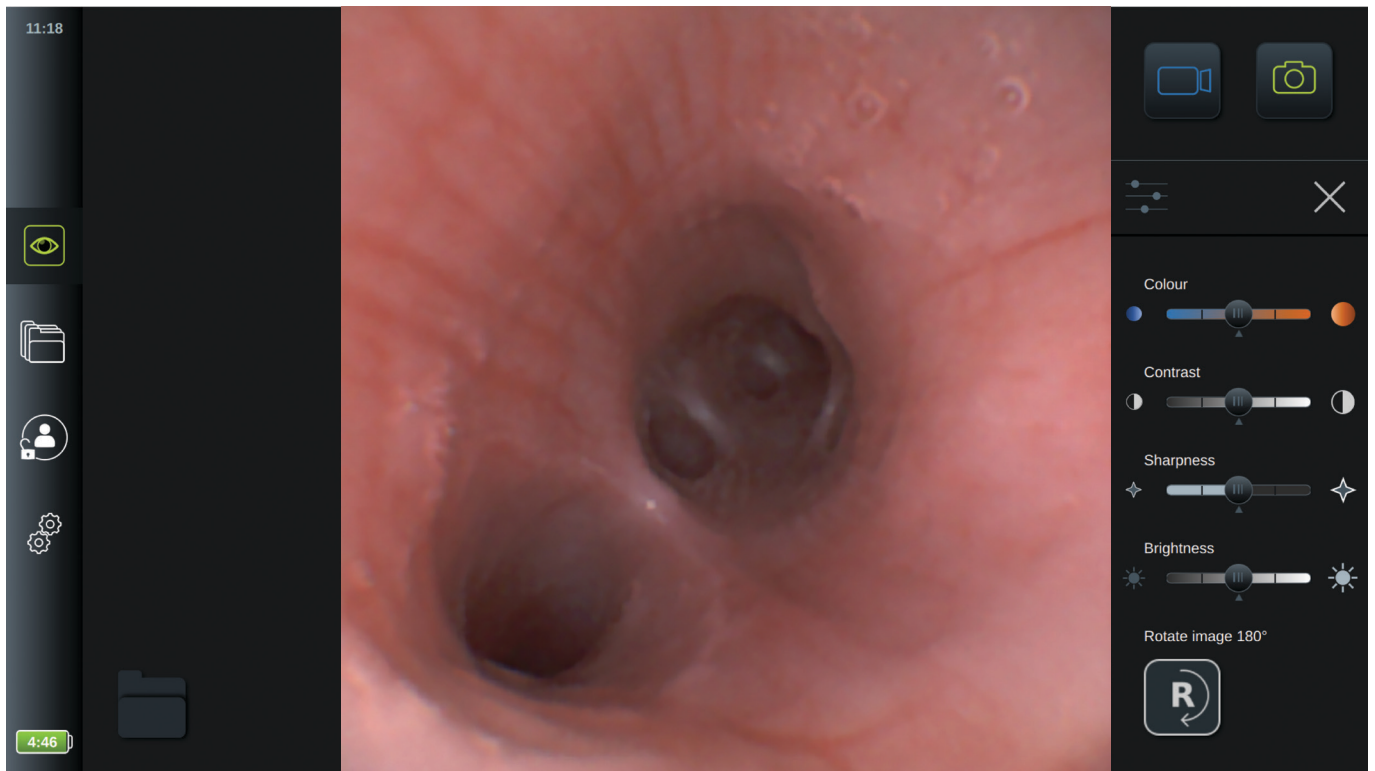

NOTE: The displaying unit will store the changes to the settings for each type visualization device individually and use these when the same type of visualization device is connected. As an example, if the settings are changed for Ambu® aScope™ 4 Broncho Slim these apply to all other aScope 4 Broncho Slim endoscopes connected, but not to any other aScope 4 variants.





The default settings for each image parameter is in the middle indicated by the small arrow below the slider bar marked with a red circle.

Explanation of icons in Image Adjustments		
Icon	Name	Function
	Colour	Adjusts the image colour temperature from cold to warm.
	Contrast	Adjust the image contrast, the higher value the larger difference between dark and bright areas.
	Sharpness	Enhances the image details, the higher value the sharper image.
	Brightness	Adjusts the overall screen brightness, the higher value the more brightness.
	Image Rotation	Allows the user to rotate the live image during the procedure.

5.1.2. Rotation of live image 180 degrees

The live image in the **Live View** can be rotated 180 degrees. This function is found in the **Image Adjustment**  menu. Factory default this function is disabled. It can be enabled under General settings (see section 4.2.5)

To activate live image rotation:

- Open the **Image Adjustment**  menu and press **Image Rotation** .
- The live image will rotate and a symbol  will appear in the upper right corner of the live image. This symbol  indicates that the image is rotated 180 degrees compared to default orientation.
- To return image orientation back to normal, press the **Image Rotation**  again.

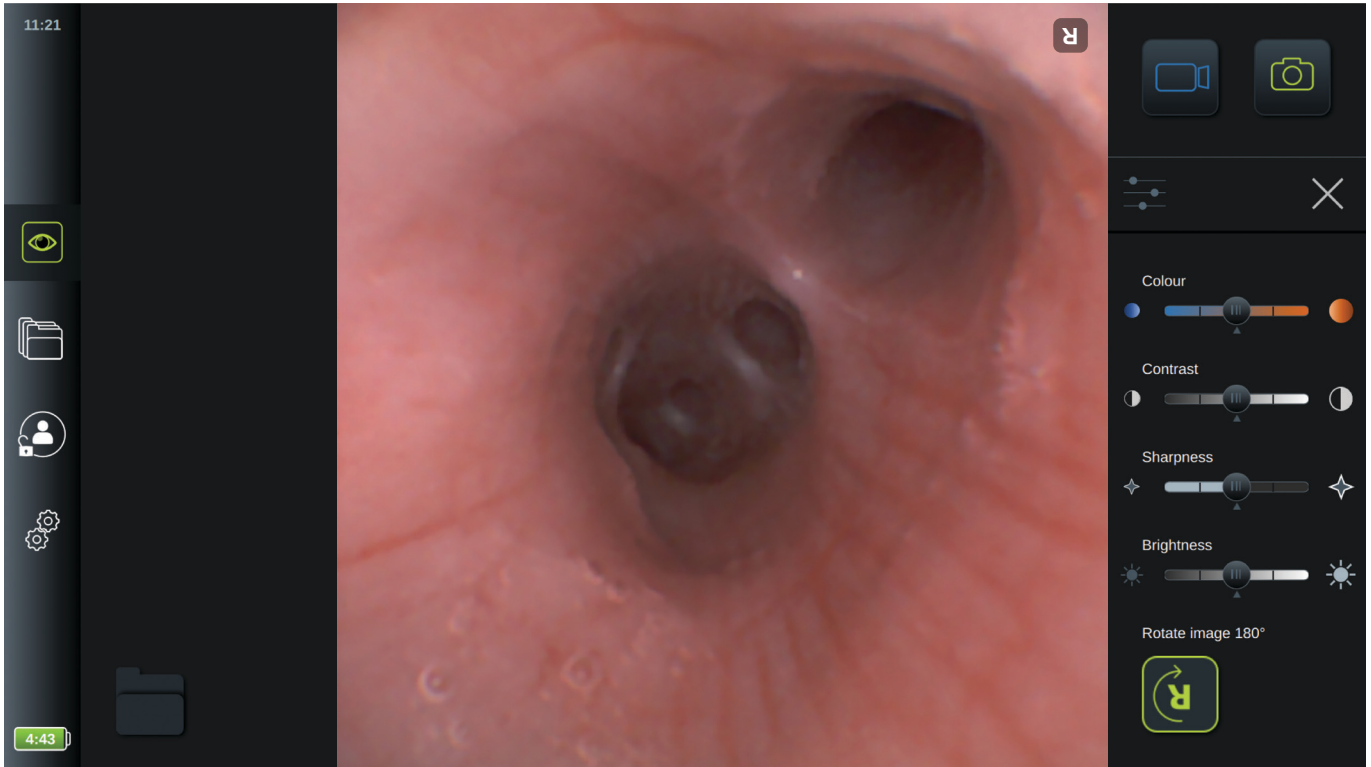

The displaying unit will remember the setting of the image rotation, also when the system is restarted.

NOTES:



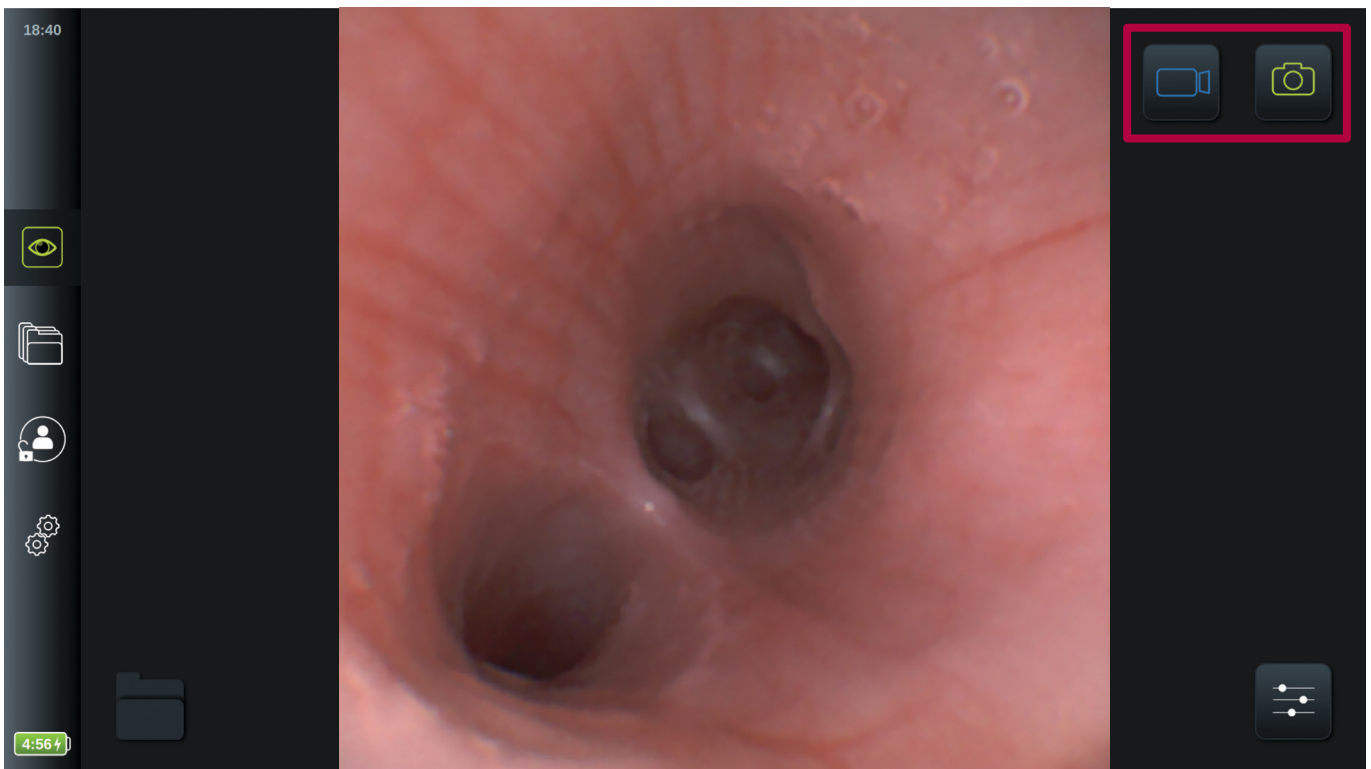

- The images and video are recorded in rotated orientation, but the inverted **R** icon is not saved in the recording.
- The image rotation function is not active when the user interface is loading. Refer to the IFU for further information on how to check image orientation.
- Image rotation can be disabled in the General Setting menu (see section 4.2.5).

5.1.3. Recording images and videos

The displaying unit can record still images and video sequences of the live image using the recording icons in the upper right corner of the user interface.



To record an image or video:



- Press the green **Snapshot**  button or **Video Recording**  button to take a still image or video sequence during the procedure.
- While recording a video, it is possible to take snapshots by pressing the **Snapshot**  button.
- A thumbnail of the recorded image or video will appear in the dark area left of the live image and animate into the **Current Procedure**  folder located in the lower left corner
- A number on the folder will appear which indicates the number of images and videos recorded and stored for the attached visualization device.

Maximum video recording length



The maximum duration of a recorded video sequence is 30 minutes. A notification will be shown in the user interface area when the time limit is about to be reached. The recording will stop automatically when the limit is reached, and the thumbnail will show and animate into the procedure folder.



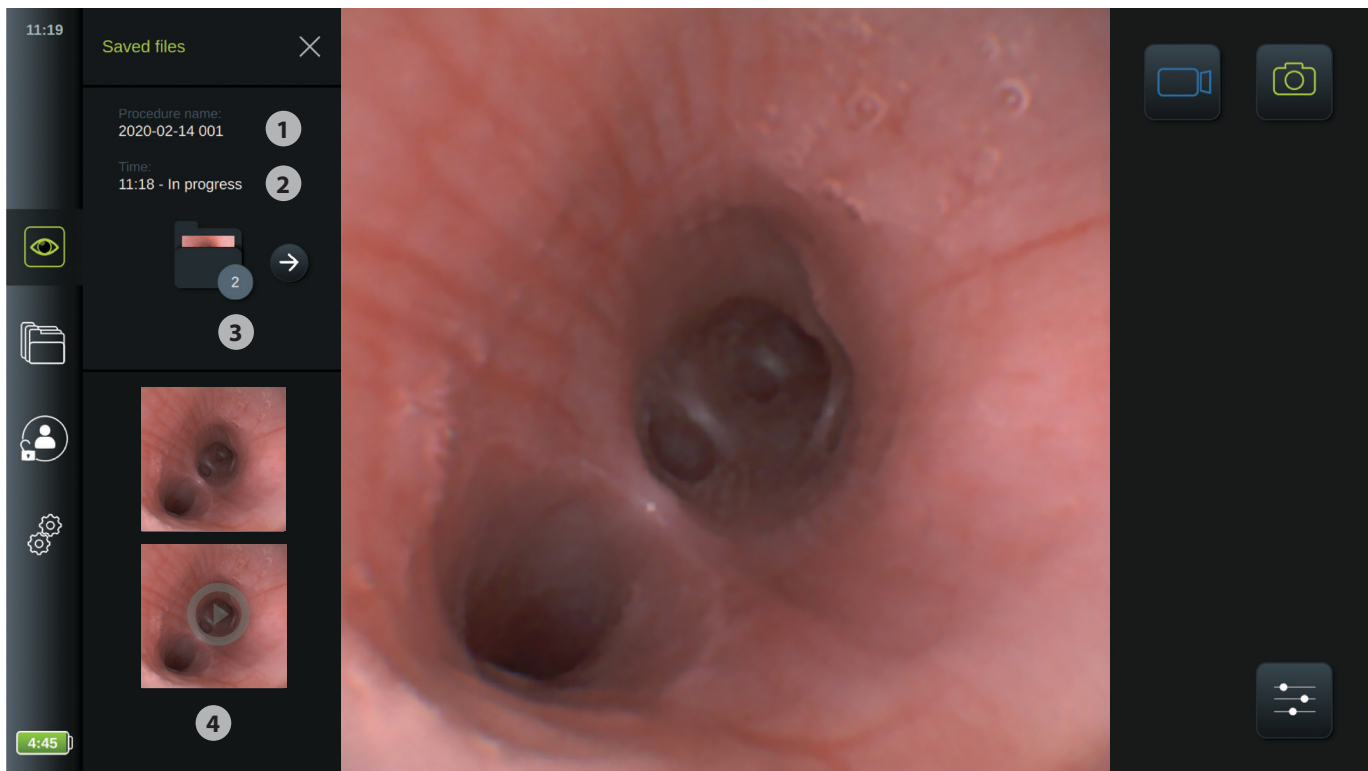

See also sections 5.2 for information on access to stored images and videos.

5.1.4. Access recorded images and videos in Current Procedure folder

When an Ambu visualization device is connected to the displaying unit, a procedure folder, called **Current Procedure** , is created. This folder is used to store recorded images and videos. The folder is unique to the specific visualization device on the specific displaying unit, and the same folder is used if the visualization device is unplugged and plugged in again. To open the **Current Procedure** folder, press the icon  in the bottom left corner.



The **Current Procedure**  folder is now shown in the left side to the screen. The list of saved items shows the **Procedure name** **1** and the **Time** **2** at which the visualization device was first connected. The number **3** on the **Current Procedure**  folder icon show how many recordings have been made in the procedure.



- Scroll **4** to see all available recordings from the procedure. All recordings from the procedure are shown in descending order with the newest at the top.
- You can choose to view a specific recorded file by pressing it directly in the Current Procedure folder. This will open the file directly in the **Archive**  recordings view (see section 5.2.3).
- To access the current procedure overview in the **Archive** , press the arrow  (see section 5.2.1).
- Press **< Back** or press the **Live View**  tab to go back to the live image when the procedure overview or a recording is opened through the Current Procedure Folder.

When a procedure is ended by disconnecting the visualization device, the **Current Procedure**  folder will open automatically to show the recorded files. If no files are recorded, the procedure folder is created internally in the displaying unit to recognize the visualization device if connected again. Administrators have privileges to see these empty procedure folders in the Archive but these are not visible to Advanced Users.

For information on file export options see section 5.2.5.

5.1.5. Zoom

When a visualization device is connected to the displaying unit, it is possible to expand the size of the image by zooming in slightly on the live image. The shown zoom image is obtained by expanding the image horizontally and cropping the top and bottom. It is not possible to move the zoom area.

- To activate zoom double tap on the image. The live image will expand and a **Zoom**  icon will appear next to the image.
- Exit the zoom view either by double tapping the live image or by pressing the **Zoom**  icon once.

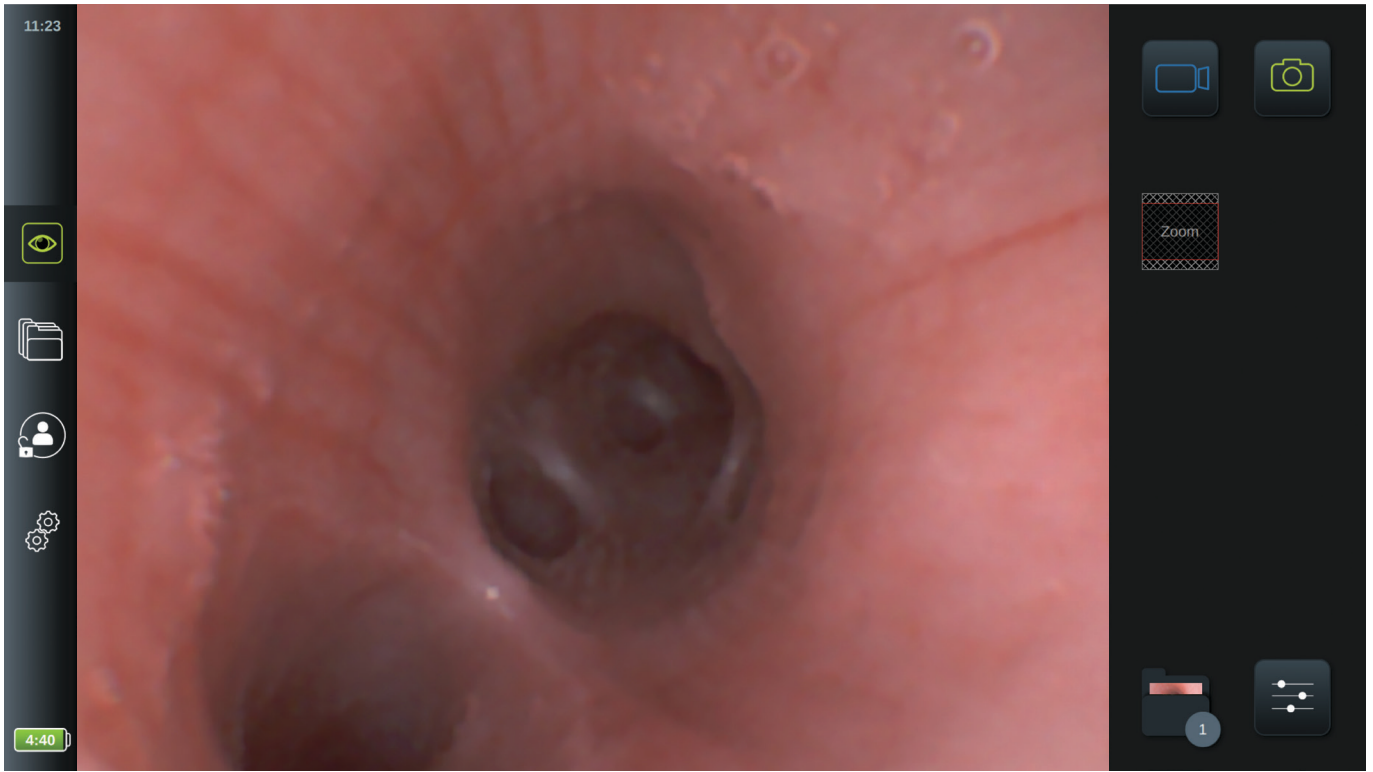

The **Zoom**  icon indicates which part of the live image is shown in the zoom view. If images or videos are recorded while using the zoom function, the original full-size image area is recorded as if the zoom function was not activated.

If the **Current Procedure**  folder is opened while Zoom is active, the image will return to normal size.



5.1.6. Dual View

The displaying unit can show two live images simultaneously when two Ambu visualizations devices are connected in at the same time (see section 3.8).

The displaying unit will show two live images: a bigger image on the left and a smaller image on the right. The images are not overlapping. In the upper left corner of each live image a roman numeral (I, II, III) is indicating which visualization device is displayed in each image. The roman numerals refer to the corresponding roman numerals placed by each of the connector ports on the side of the displaying unit.

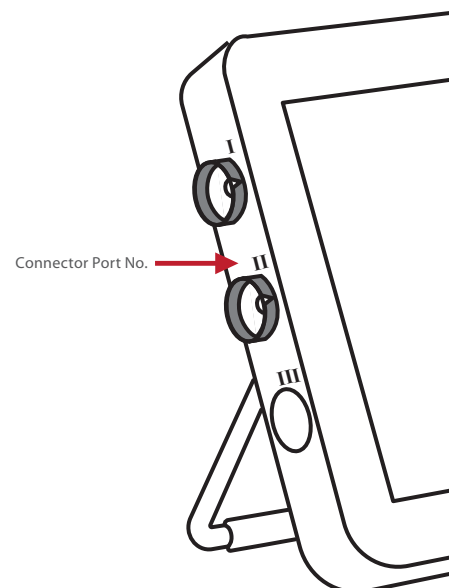
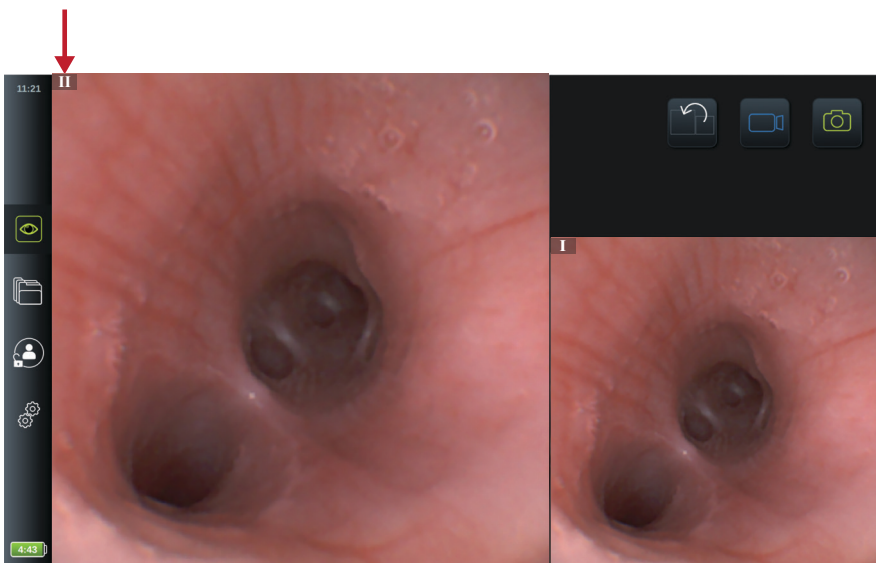

Connector Port No.



When two Ambu visualization devices are connected, only the **Image Switch**  button, the **Snapshot**  button or **Video Recording**  button are available.



Press the **Image Switch**  button to swap the locations and size of the live images from the two visualization devices.

NOTES:

- When recording images or videos while using dual view, these are saved in the separate procedure folders for each visualization device. The recordings can be accessed in the **Archive**  tab (see section 5.2 Archive).
- If one visualization device is connected and recording video, while a second visualization device is connected, no recording from the second device will be saved.
- To change **Image Adjustment**  for one visualization device, disconnect the other visualization device to exit dual view. When the settings are changed, connect the other visualization device again to re-activate **Dual View**.
- The procedure folder is not accessible while using dual view. The recordings can be accessed through the **Archive** . To get access to Archive, log in as **Advanced** or **Administrator** (see section 4.1 How to log in).

5.2. Archive

In the **Archive**  recordings from all previous procedures can be found. The recordings are saved in procedure folders which are unique for each visualization device connected to the displaying unit (see section 5.2.1).

To access the **Archive** , log in as **Advanced User** or **Administrator** (see section 4.1). Press the **Archive**  tab in the tool bar and press **Recent**  1.

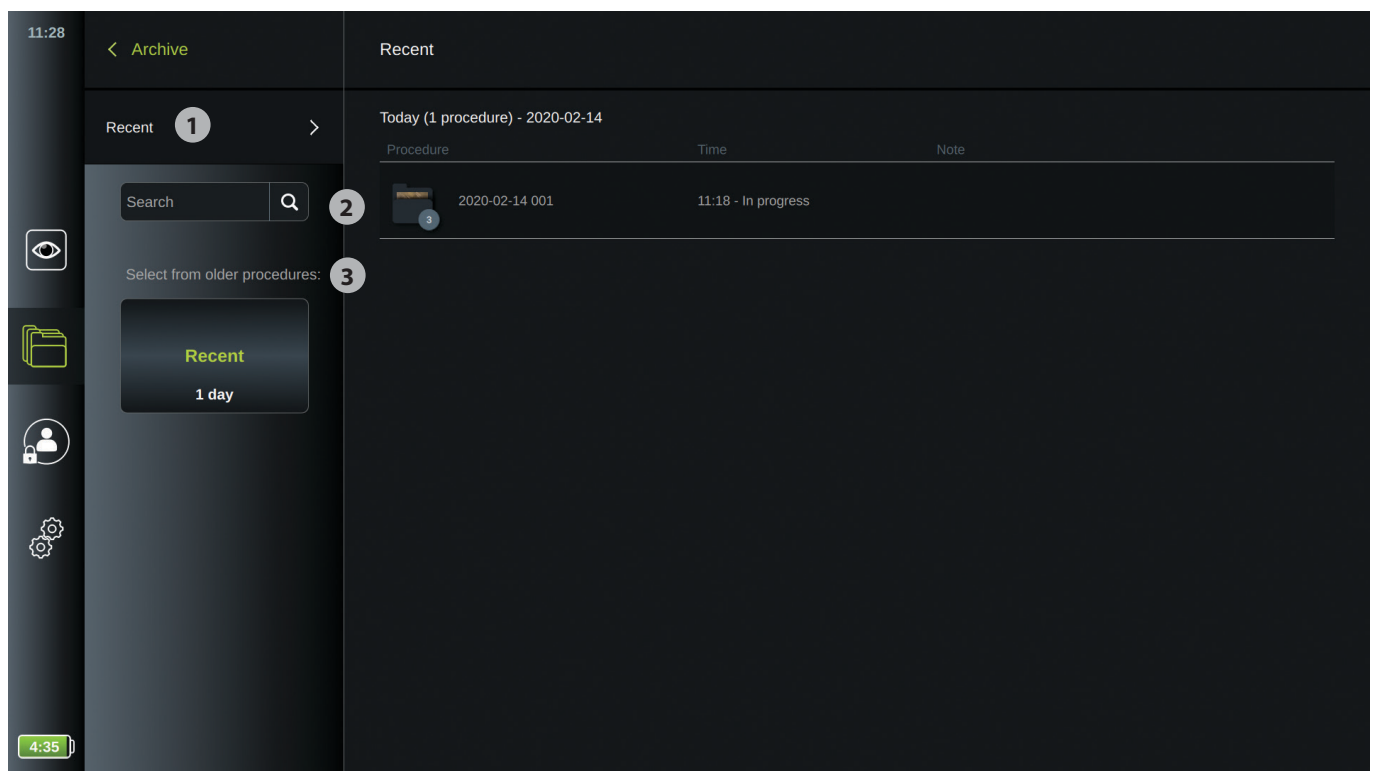

Under **Recent**, all procedure folders are shown in descending order with the newest at the top. In the list of procedure folders, you will find the Procedure name, Time of procedure, and any Notes written for the specific procedure (see section 5.2.1).

The procedure name consists of the date of the procedure and the procedure number of the day. The format is: YYYY-MM-DD_XXX, where XXX is the procedure number.

NOTE: Ensure that the date is set correctly in the system to have procedures saved with the correct information.

The procedure folder icon  is also shown with an indication of the number of imaging files (images and/or videos) that the particular procedure contains. When the procedure list fills beyond the content of the screen, a scroll bar will appear in the right of the procedure overview.

The **Search** **2** field can be used to find specific procedures. Press the field and type a procedure date or words from a note added to a specific procedure.

- You can also choose to filter the procedure list to only see procedures in a given date range. Use the **Select range** **3** wheel to select and view a wider or narrower range of procedure folders.
- The list will filter automatically when a range is selected.
- To get a full overview, move the range selector back to **Recent**.

Additional Administrator privileges in Archive

As Administrator you can clean up the procedure archive by deleting multiple procedure folders. Administrators can also see all empty procedure folders, which are created for connected visualization devices where no recordings are made. These empty procedure folders are not visible to other users.

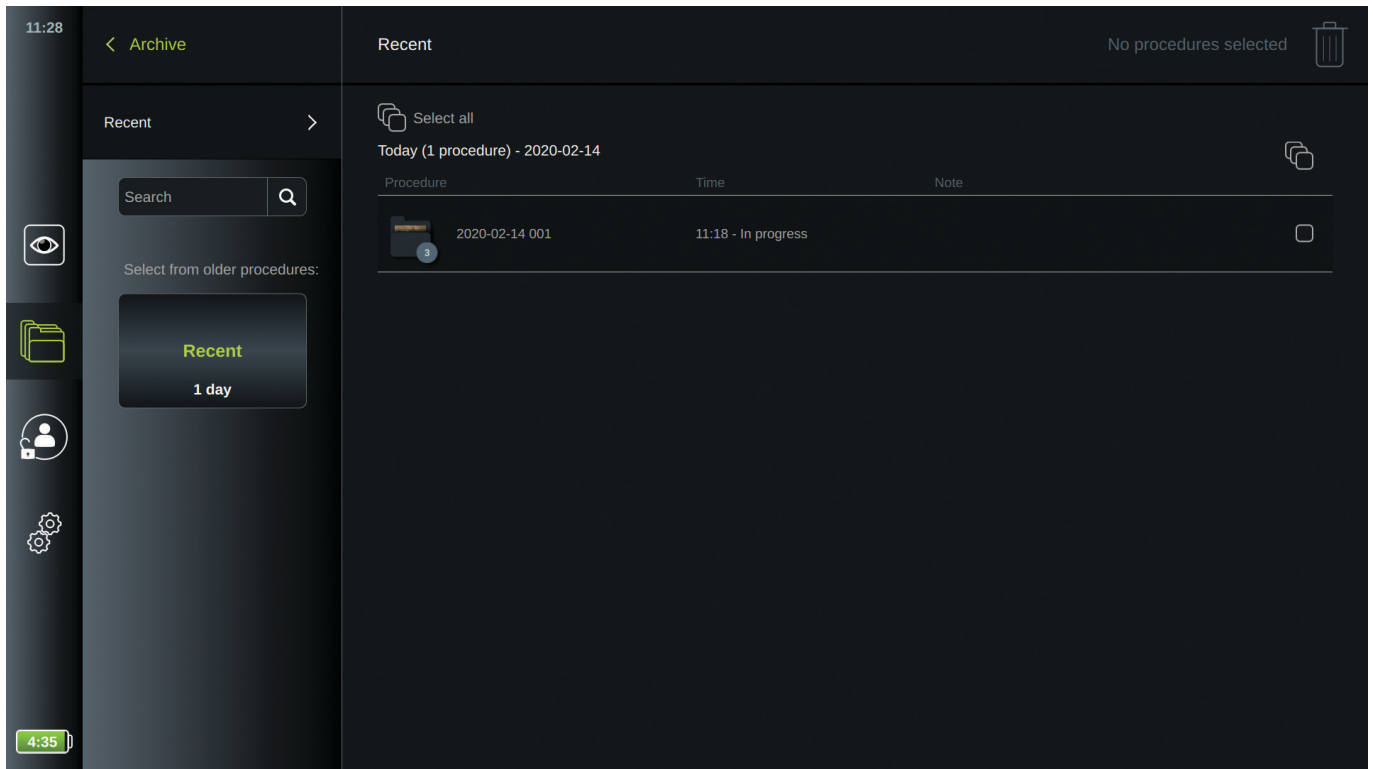

To delete procedure folders, select the individual folders to be deleted by pressing the **Selection box** , or used **Select all** to select all folders in the specified date range. When selection is made, the **Selection box** changes to and **Select all** will change to . Press the **Trash Can** shown in the top right corner of the screen when logged in as Administrator.

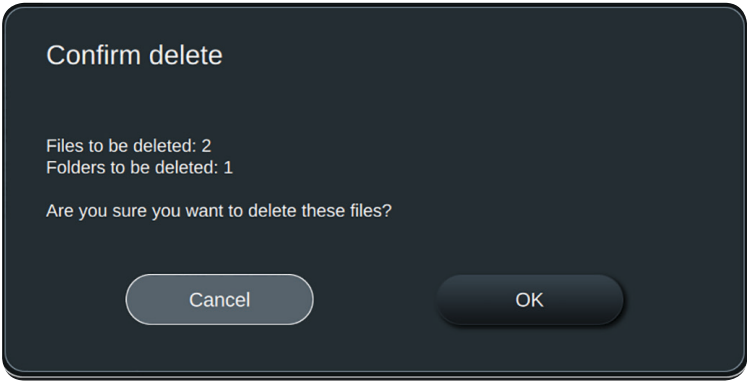



The dialog box is titled 'Confirm delete'. It contains the text: 'Files to be deleted: 2', 'Folders to be deleted: 1', and 'Are you sure you want to delete these files?'. At the bottom are two buttons: 'Cancel' and 'OK'.



A pop-up window will show and indicate how many folders you are about to delete. Press **OK** to confirm deleting or cancel to return to the overview.



5.2.1. Viewing Procedure Folder in Archive

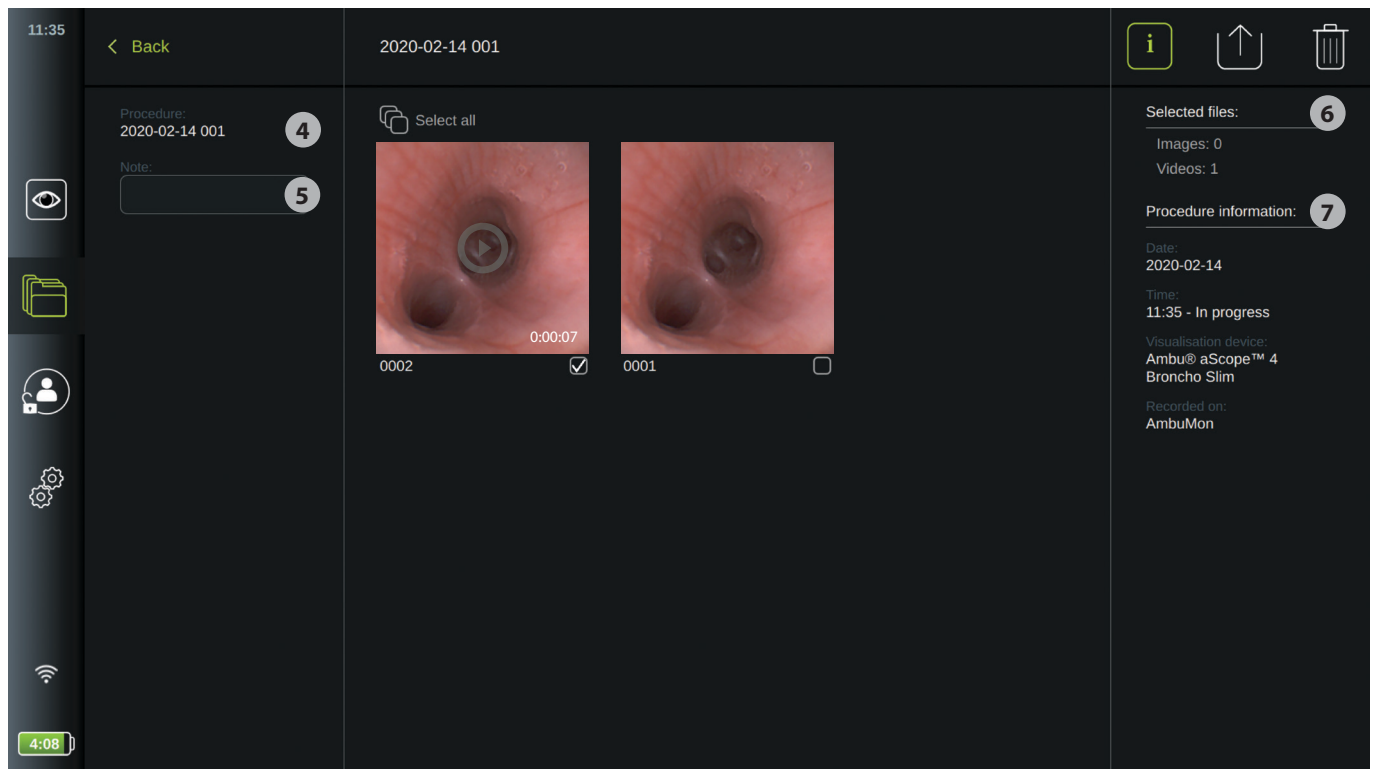

In the **Procedure folder**  an overview of all recordings and information from the specific procedure is shown.

- To access, press a **Procedure folder**  in the procedure list in the **Archive**  to view its content.



In the left side of the screen the **Procedure name**  and a **Notes**  field is shown. The notes field can be used for adding a short description to the specific procedure.

In the right side of the screen the number of **Selected files**  and the **Procedure information**  is shown. The **Procedure information** includes **Date** for procedure, **Time** of day the procedure was done, **Duration** of procedure defined as when the visualization device was connected first time and disconnected last time, the type name of **visualization device** used for the procedure, and the name of the specific displaying unit (set up in **Settings** as **Device Name**).

All the recorded images and videos in the procedure are shown in descending order with the newest recording at the top left. Below each recording is the file name and a selection box . The **Select all**  icon is found above the recordings overview

The file name is: XXXX, indicating the image count, starting from 0001. The count does not change when other files are deleted.

5.2.2. Adding a procedure note

The note field is intended for short descriptions about the procedure and the space is limited to 40 characters. The procedure note is stored on the displaying unit with the procedure and part of the folder name when exporting image data to USB (see section 5.2.5).

To add a note, press the **Note**  field and use the keyboard to type.

User are advised not to add Protected Health Information (PHI) to the Notes area nor include PHI in the images or videos as the risk of revealing PHI to non-authorized users may increase considerably.

5.2.3. Viewing recordings

To view a recorded image or video, press the recording you would like to view. Now the recording will be shown in full size.

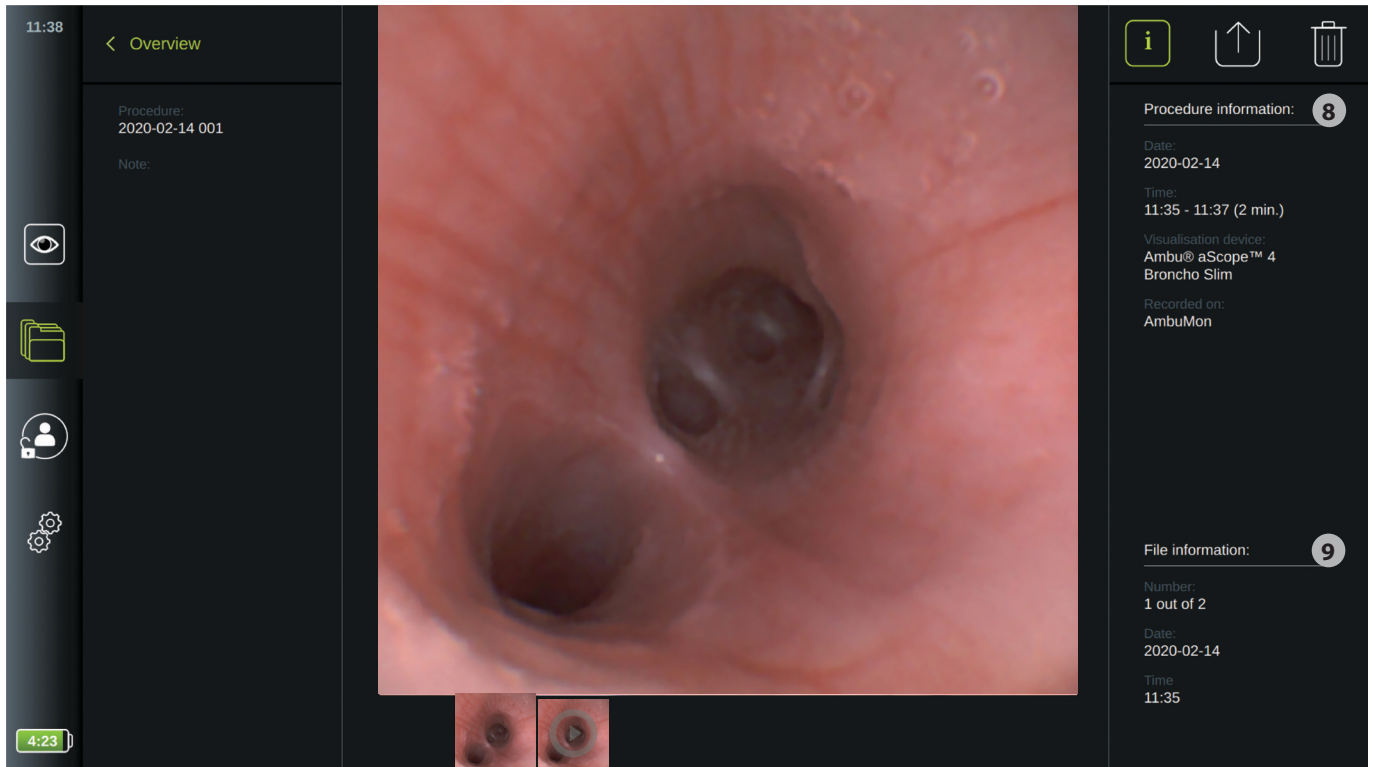

Below the full-size image, all recordings from the procedure are shown in descending order with the newest to the left. Scroll sideways on the thumbnails to see all recordings from the procedure.

On the right side, **Procedure information** 8 is listed followed by the **File information** 9 for the viewed recording. These data are stored on the displaying unit with the files and not exported to USB and PACS. On the left side you will find, the procedure name and any notes written for the procedure.

To playback a video:

- Press the **play** 10 in the centre of full-size video to view it. A **playback bar** is shown below the playing video.
- To stop/pause the video, press **pause** 10.
- To step forward and backwards, frame-by-frame, in the video, use the **arrows** 11 after **pause** 10 has been activated.
- To jump to a specific time or location in the video, tap the playback bar at the preferred location. You may also slide the **knob** 12 sideways to fast-forward and rewind in the video.

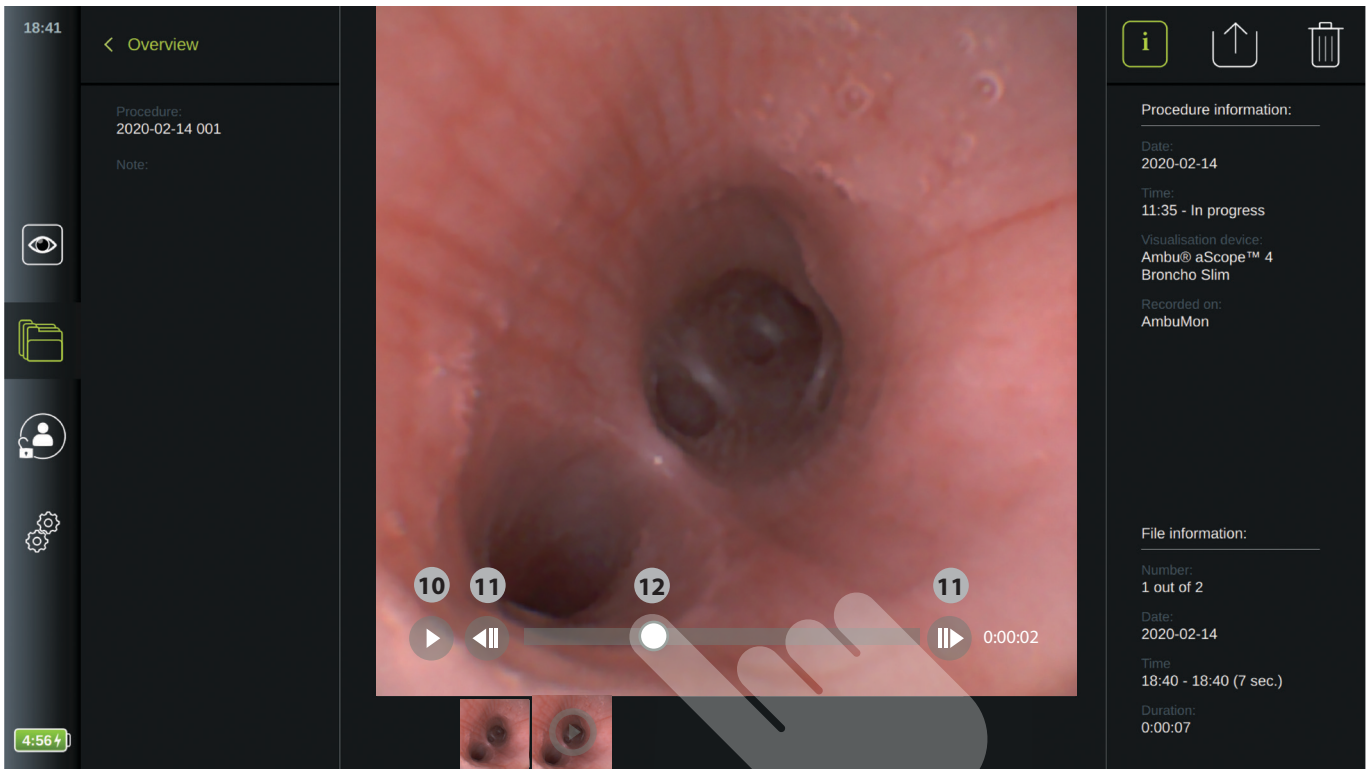

NOTE: It is not possible to take screenshots from a recorded video. Please use the snapshot feature in the Live View during the procedure for taking still images.

5.2.4. Deleting files

You can delete recorded images and videos in a procedure folder.

	<p>To delete files in the Procedure Folder overview:</p> <ul style="list-style-type: none"> Use Selection box or Select all to select the recording(s) to be deleted. Press the Trash Can to delete selected files. A pop-up confirmation window will appear prior to deleting to show how many files are about to be deleted and for you to confirm. To proceed with delete, press OK, or press Cancel to stop.
	<p>You may also delete a file directly in the file viewer:</p> <ul style="list-style-type: none"> Press the Trash Can to delete the viewed recording. A pop-up window will ask you to confirm deleting the file. Press OK to delete or Cancel to stop.

5.2.5. Export to USB or PACS

Images and videos recorded on the displaying unit can be exported to connected USB storage devices or to a PACS (Picture Archiving and Communication System – see section 4.2.4 for setup).

The recordings can be exported in two formats: **DICOM** (Digital Imaging and Communications in Medicine) **format** and standard format called **BASIC**.

When recordings are exported in BASIC format to USB, they are stored in the following formats:

Storage settings	
Image (snapshot)	PNG (400 x 400 pixels) – no compression
Video	MP4 - compressed

When files are exported to USB, they are placed in a folder with a name composed by the procedure name and the note (if any). Example below the procedure name is 2020-02-04 001 and the note written is “For teaching”. The exported files in the folder will be called; YYYY-MM-DD XXX XXXX, Where XXX is the procedure count and XXXX is the image count within the procedure.

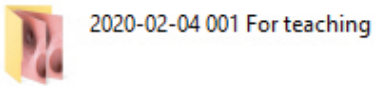

To export files, go to the **Procedure folder** to view all recordings in the procedure. Use the **Selection boxes** to select individual or all files in the procedure to export. When files have been selected, press the **Export**  icon in the top right corner of the screen.

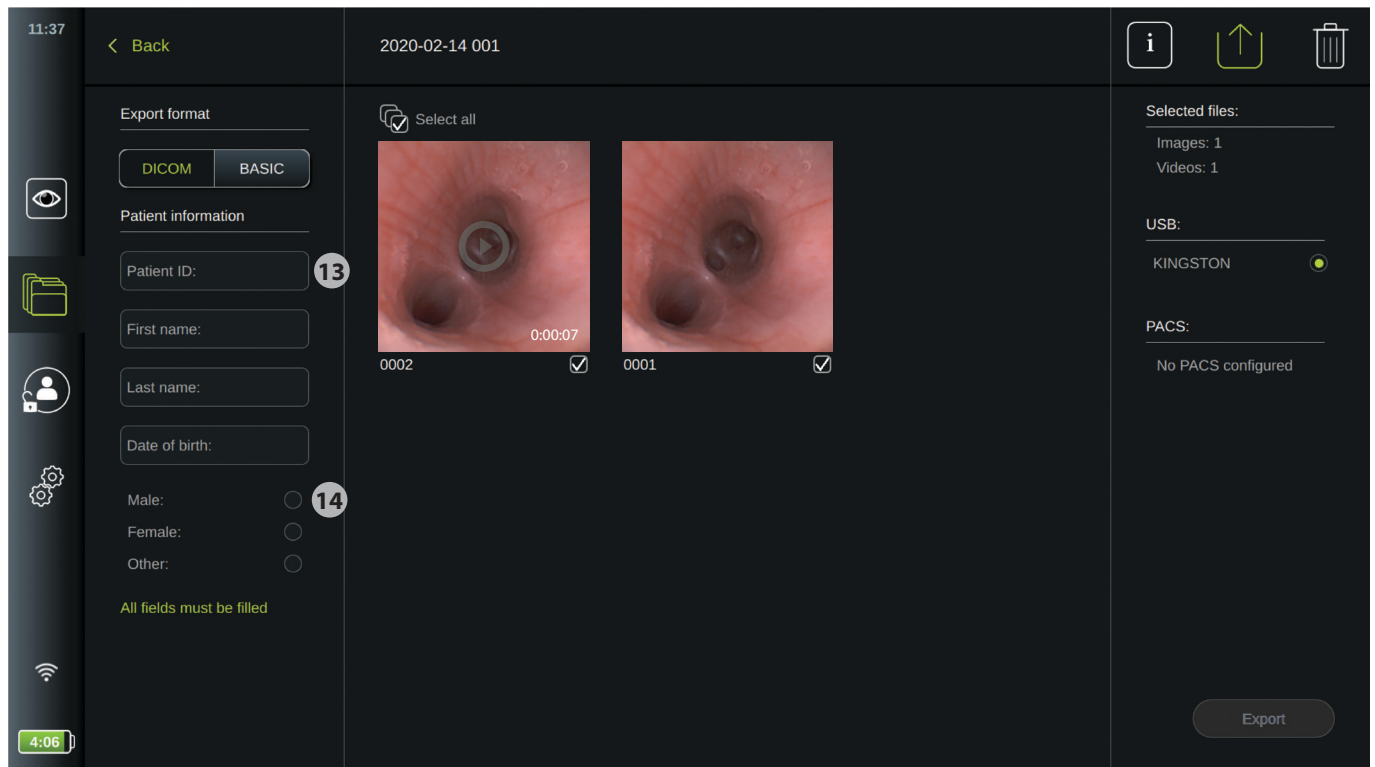

In the left side of the screen, you can now choose the export format: **DICOM** format or **BASIC** image. When opening the export menu, the last used format will be active.

To export in BASIC format (to USB only):

- Press on **BASIC**
- Select a connected **USB** in the right side of the screen.
- Press **Export**

To export in DICOM format to a PACS or USB (for manual transfer to PACS):

- Press on **DICOM** (if view not selected already)
- Enter patient information **13**.
All fields must be filled out. Choose the first field, fill it out, and use the **arrows >** to go to the next field.
Patient ID (e.g. the patients social security number or other ID code)
First name of the patient
Last name of the patient
The patient's **Date of Birth**.
- Select gender by pressing **Male, Female** or **Other** **14**.
- Select a connected **USB** or **PACS** server in the right side of the screen.
- Double check your entered patient data prior to exporting.

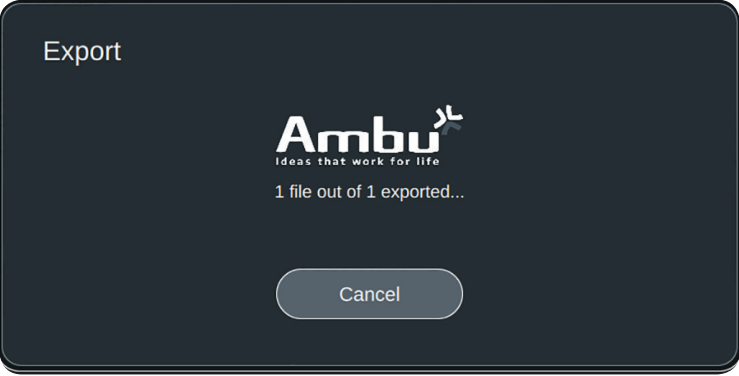
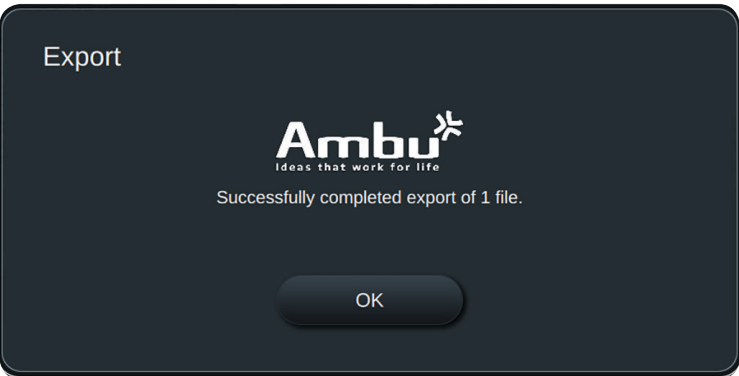
	<p>When you are ready to export, press Export in the lower right corner. While the files are being exported a pop up is shown to inform in the progress. If you need to stop the export, press Cancel.</p>
	<p>A pop-up window will indicate that exporting has completed. Press OK to finalize exporting.</p>

NOTES:

- Always check that the entered patient data is correct when exporting to PACS.
- Protected Health Information (PHI) for the patient is not stored on the displaying unit. They are only used to send with the DICOM files to the PACS for correct identification and storage.
- Always use a secure network when exporting files from the displaying unit.
- You will not be able to export images and videos to PACS if the displaying unit is not connected to the network (Wi-Fi or LAN). If a network error occurs in your organization while exporting, the export will be canceled. You can instead export files to a USB device or wait till the network is recovered before exporting to PACS.

6. System information and upgrade

You can find system information and get access to the system upgrade menu in **About** under the **Settings**  tab in the toolbar.

6.1. Device information page

In **Device Info** under the **About** menu you can get an overview of the system information and conditions.

- Press the **Settings**  tab in the tool bar on the left
- Press **About**, and the **Device Info**  menu will be open

Here you can view information such as serial number, software (SW) version, build time and disk size. This menu also gives you an overview of the current system conditions such as disk space and device temperature.

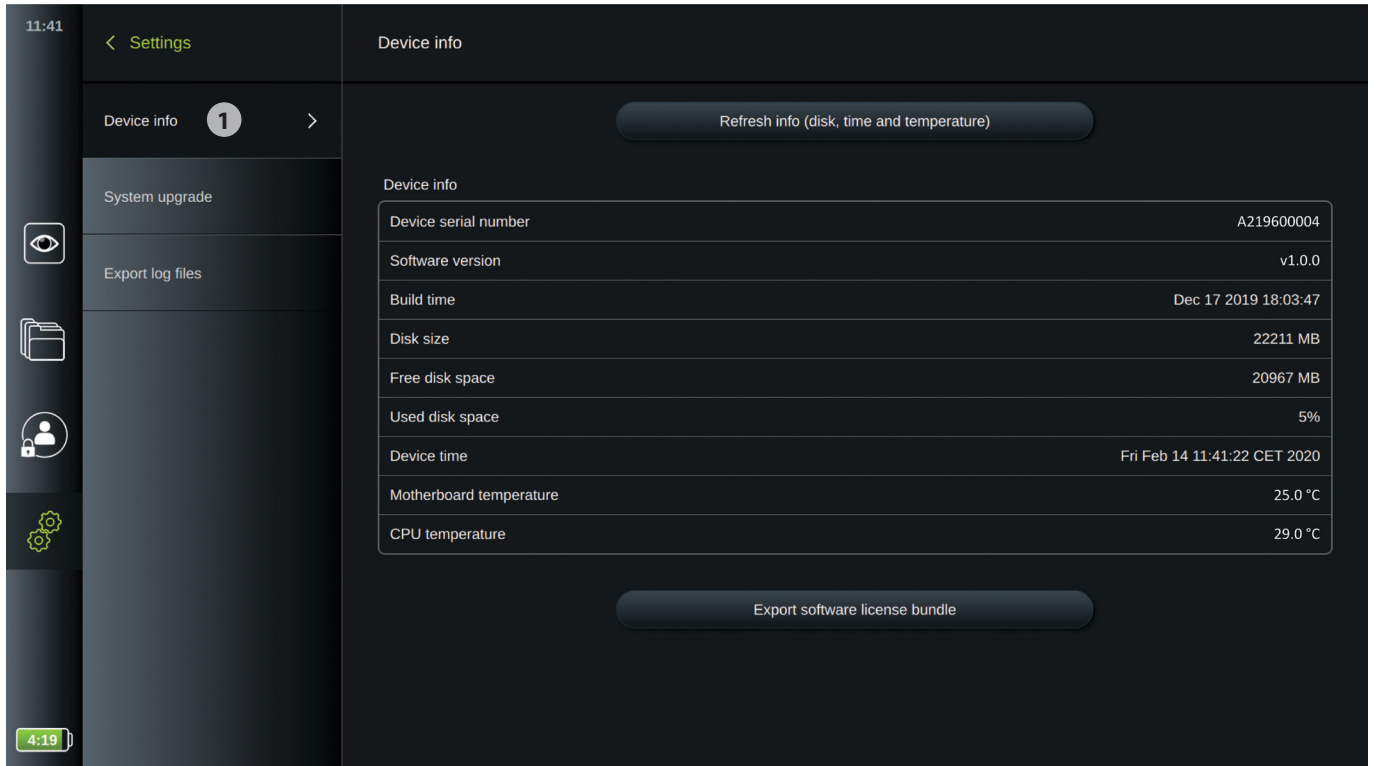

6.2. System upgrade

In **System Upgrade** under the **About** the system upgrade function is placed.

The software can only be upgraded by Ambu. For more information contact your local Ambu representative.

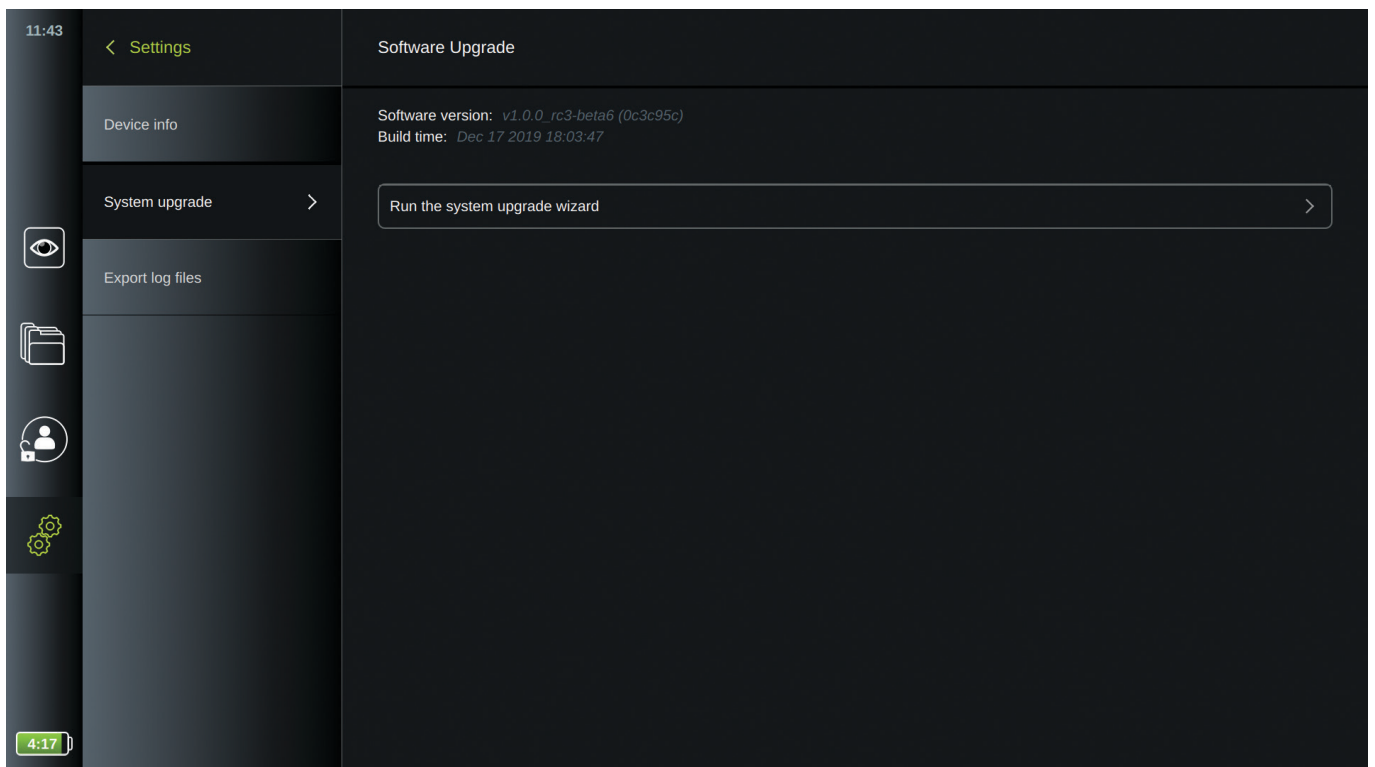



6.3. Reporting a Problem

In case you are experiencing problems with the displaying unit, please follow the troubleshooting guidelines in the IFU to find a solution. If this does not help you, please contact your local Ambu representative.

6.3.1. Export Log Files

Log files can be exported from the displaying unit. The log file consists of compressed text files containing information about the displaying unit system. The log file is used by Ambu for troubleshooting purposes.

Please follow these steps to export a log file to a USB device:

- Connect a portable USB device (see section 3.11)
- Go to **Settings**  and open the **About** menu
- Press **Export log files**  **1**, and press the **Export**  icon

A pop up window will inform you if the export was successful

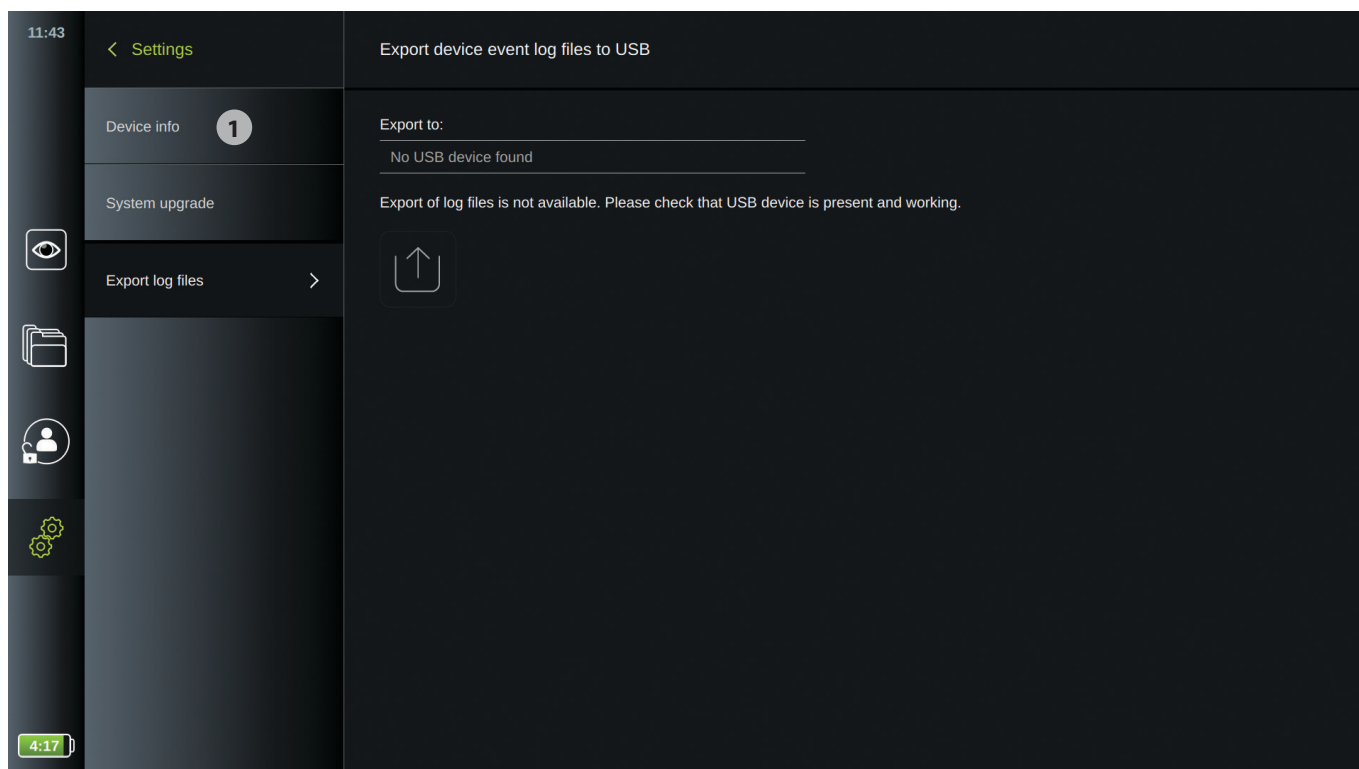

6.4. Backup

It is recommended to make a backup of your files on a regular basis by exporting videos and images to an external storage location (USB device or PACS server) in the event there should be a problem with the internal displaying unit storage.

It is not possible to import imaging files to store in the internal memory. Setup data cannot be exported. In case they are lost, it is necessary to re-enter these.

Appendix 1. Electromagnetic Compatibility

Like other electrical medical equipment, the system requires special precautions to ensure electromagnetic compatibility with other electrical medical devices. To ensure electromagnetic compatibility (EMC) the system must be installed and operated according to the EMC information provided in this manual. The system has been designed and tested to comply with IEC 60601-1-2 requirements for EMC with other devices.

Guidance and manufacturer's declaration – electromagnetic emission		
The system is intended for use in the electromagnetic environment specified below. The customer or the user of the system should assure that it is used in such an environment.		
Emissions Test	Compliance	Electromagnetic Environment Guidance
RF emission CISPR 11	Group 1	The system uses RF energy only for its internal function. Therefore, its RF emissions are very low and are not likely to cause any interference in nearby electronic equipment.
RF emission CISPR 11	Class A	The system is suitable for use in all establishments other than domestic, and may be used in domestic establishments and those directly connected to the public low-voltage power supply network that supplies buildings used for domestic purposes, , provided the following NOTE 1 is heeded.
Harmonic emission IEC/ EN 61000-3-2	Not applicable	
Voltage fluctuations / flicker emissions IEC/EN 61000-3-3	Complies	

NOTE 1: The emissions Characteristics of this equipment makes it suitable for use in industrial areas and hospitals (CISPR 11 class A). If it is used in a residential environment (for which CISPR 11 class B is normally required) this equipment might not offer adequate protection to the radio-frequency communication service. The user might need to take mitigation measures, such as relocating or re-orienting the equipment.

Guidance and manufacturer's declaration – electromagnetic immunity

The system is intended for use in the electromagnetic environment specified below.
The customer or the user of the system should assure that it is used in such an environment.

Immunity test	IEC 60601-1 test level	Compliance Level	Electromagnetic Environment Guidance
Electrostatic discharge (ESD) IEC 61000-4-2	+/- 8 kV contact +/- 2, 4, 8, 15 kV air	+/- 8 kV contact +/- 2, 4, 8, 15 kV air	If floors are covered with synthetic material the relative humidity shall be least 30 %.
Electrical fast transient / burst IEC 61000-4-4	+/- 2 kV for power supply lines +/- 1 kV for input / output lines	+/- 2 kV power supply lines N/A	Mains power quality shall be that of a typical commercial or hospital environment.
Surge IEC 61000- 4-5	+/- 1 kV line(s) to line(s) +/- 2 kV line(s) to earth		Mains power quality shall be that of a typical commercial or hospital environment.
Voltage Dips, short interruptions and voltage variations on power supply input lines IEC 61000-4-11	<5% Ut (95% dip in Ut) for 0.5 cycle 40% Ut (60% dip in Ut) for 5 cycles 70% Ut (30% dip in Ut) for 25 cycles <5% Ut (95% dip in Ut) for 5 sec.	100% reduction 0.5 period 40% reduction for 5 periods 30% reduction for 25 periods 100% reduction for 5 sec.	Mains power quality shall be that of a typical commercial or hospital environment. If the use of the system requires continued operation during power mains interruptions the system can be powered by the built-in rechargeable battery.
Power frequency (50/60 Hz) magnetic field IEC 61000-4-8	30 A/m	30 A/m	Power frequency magnetic fields should be at levels characteristic of a typical location in a typical commercial or hospital environment.

Guidance and manufacturer's declaration – electromagnetic immunity

The system is intended for use in the electromagnetic environment specified below.
The customer or the user of the system should assure that it is used in such an environment.

Immunity test	IEC 60601 test level	Compliance level	Electromagnetic Environment Guidance
Conducted Radio Frequency IEC 61000-4-6	3 V RMS 0,15 MHz – 80 MHz 6 V RMS in ISM bands 80 % AM at 1 kHz	3 V RMS 0,15 MHz – 80 MHz 6 V RMS in ISM bands 80 % AM at 1 kHz	Portable and mobile RF communications equipment should be used no closer to any part of the system, including its cables, than the recommended separation distance calculated from the equation applicable to the frequency of the transmitter. Recommended separation distance $d = 1.17\sqrt{P}$ $d = 1.17\sqrt{P}$ 80 MHz to 800 MHz $d = 2.33\sqrt{P}$ 800 MHz to 2.7 GHz
Radiated Radio Frequency IEC 61000-4-3	3 V/m 80 MHz to 2.7 GHz 80 % AM at 1 kHz	3 V/m 80-2700 MHz 80% AM at 1 kHz	Where P is the maximum output power rating of the transmitter in watts (W) according to the transmitter manufacturer and d is the recommended separation distance in metres (m). Field strengths from fixed RF transmitters, as determined by an electromagnetic site survey: a) Should be less than the compliance level in each frequency range. b). Interference may occur in the vicinity of equipment marked with the following symbol. 

NOTE 1: At 80 MHz, the higher frequency range applies.

NOTE 2: These guidelines may not apply in all situations. Electromagnetic propagation is affected by absorption and reflection from structures, objects and people.

- a) Field strengths from fixed transmitters, such as base stations for radio (cellular/cordless) telephones and land mobile radios, amateur radio, AM and FM radio broadcast, and TV broadcast, cannot be predicted theoretically with accuracy. To assess the electromagnetic environment due to fixed RF transmitters, an electromagnetic site survey shall be considered. If the measured field strength in the location in which the system is used exceeds the applicable RF compliance level above, the system shall be observed to verify normal operation. If abnormal performance is observed, additional measures may be necessary, such as reorienting or relocating the system.
- b) Over the frequency range 150kHz to 80MHz, field strengths shall be less than 3 V/m.

Recommended Separation Distances Between Portable and Mobile RF Communication Equipment and system.

The system is intended for use in an electromagnetic environment in which radiated RF disturbances are controlled. The user of the system can help prevent electromagnetic interference by maintaining a minimum distance between portable and mobile RF communications equipment (transmitters and the system as recommended below, according to the maximum output power of the communication equipment.

Rated maximum output power (W) of transmitter	Separation distance (m) according to frequency of transmitter		
	150kHz to 80MHz $D = 1.17\sqrt{P}$	80MHz to 800MHz $D = 1.17\sqrt{P}$	800MHz to 2.7GHz $D = 2.33\sqrt{P}$
0.01	0.12 m	0.12 m	0.23 m
0.1	0.37 m	0.37 m	0.74 m
1	1.17 m	1.17 m	2.33 m
10	3.70 m	3.70 m	7.37 m
100	11.7 m	11.7 m	23.3 m

For transmitters rated at a maximum output power not listed above, the recommended separation distance (D) in meters (m) can be estimated using the equation applicable to the frequency of the transmitter, where P is the maximum output power rating of the transmitter in watts (W) according to the transmitter manufacturer.

NOTE 1: At 80 MHz and 800 MHz, the separation distance for the higher frequency range applies

NOTE 2: These guidelines may not apply in all situations. Electromagnetic propagation is affected by absorption and reflection from structures, objects and people.

Appendix 2. Radio Frequency Compliance

To ensure Radio Frequency Compliance (RF) the system must be installed and operated according to the RF information provided in this manual.

Guidance and manufacturer's declaration – Radio frequencies

This device complies with Directive 2014/53/EU issued by the Commission of the European Community.

Operations in the 5.15-5.35GHz band are restricted to indoor usage only:



Check RF regulations in the individual countries

Belgium (BE), Bulgaria (BG), Czech Republic (CZ), Denmark (DK), Germany (DE), Estonia (EE), Ireland (IE), Greece (EL), Spain (ES), France (FR), Croatia (HR), Italy (IT), Cyprus (CY), Latvia (LV), Lithuania (LT), Luxembourg (LU), Hungary (HU), Malta (MT), Netherlands (NL), Austria (AT), Poland (PL), Portugal (PT), Romania (RO), Slovenia (SI), Slovakia (SK), Finland (FI), Sweden (SE) and United Kingdom (UK).

Industry Canada statement (IC)

EN: This device complies with ISED's licence-exempt RSSs. Operation is subject to the following two conditions: (1) This device may not cause harmful interference, and (2) this device must accept any interference received, including interference that may cause undesired operation.

FR: Le présent appareil est conforme aux CNR d'ISED applicables aux appareils radio exempts de licence. L'exploitation est autorisée aux deux conditions suivantes : (1) le dispositif ne doit pas produire de brouillage préjudiciable, et (2) ce dispositif doit accepter tout brouillage reçu, y compris un brouillage susceptible de provoquer un fonctionnement indésirable.

Caution/Avertissement:

EN: (i) the device for operation in the band 5150-5250 MHz is only for indoor use to reduce the potential for harmful interference to co-channel mobile satellite systems;
(ii) where applicable, antenna type(s), antenna models(s), and worst-case tilt angle(s) necessary to remain compliant with the e.i.r.p. elevation mask requirement set forth in section 6.2.2.3 shall be clearly indicated.

FR: Le guide d'utilisation des dispositifs pour réseaux locaux doit inclure des instructions précises sur les restrictions susmentionnées, notamment:

- (i) les dispositifs fonctionnant dans la bande 5150-5250 MHz sont réservés uniquement pour une utilisation à l'intérieur afin de réduire les risques de brouillage p
- (ii) lorsqu'il y a lieu, les types d'antennes (s'il y en a plusieurs), les numéros de modèle de l'antenne et les pires angles d'inclinaison nécessaires pour rester conforme à l'exigence de la p.i.r.e. applicable au masque d'élévation, énoncée à la section 6.2.2.3, doivent être clairement indiqués

Radiation Exposure Statement/ Déclaration d'exposition aux radiations:

EN: This equipment complies with ISED radiation exposure limits set forth for an uncontrolled environment. This equipment should be installed and operated with greater than 20cm between the radiator & your body.

FR: Cet équipement est conforme aux limites d'exposition aux rayonnements ISED établies pour un environnement non contrôlé. Cet équipement doit être installé et utilisé à plus de 20 cm entre le radiateur et votre corps.

Federal Communication Commission Interference Statement (FCC)

This device complies with Part 15 of the FCC Rules. Operation is subject to the following two conditions: (1) This device may not cause harmful interference, and (2) this device must accept any interference received, including interference that may cause undesired operation.

This equipment has been tested and found to comply with the limits for a Class B digital device, pursuant to Part 15 of the FCC Rules. These limits are designed to provide reasonable protection against harmful interference in a residential installation. This equipment generates, uses and can radiate radio frequency energy and, if not installed and used in accordance with the instructions, may cause harmful interference to radio communications. However, there is no guarantee that interference will not occur in a particular installation. If this equipment does cause harmful interference to radio or television reception, which can be determined by turning the equipment off and on, the user is encouraged to try to correct the interference by one of the following measures:

- Reorient or relocate the receiving antenna.
- Increase the separation between the equipment and receiver.
- Connect the equipment into an outlet on a circuit different from that to which the receiver is connected.
- Consult the dealer or an experienced radio/TV technician for help.

FCC Caution:

Any changes or modifications not expressly approved by the party responsible for compliance could void the user's authority to operate this equipment.

This transmitter must not be co-located or operating in conjunction with any other antenna or transmitter.

This device meets all the other requirements specified in Part 15E, Section 15.407 of the FCC Rules.

Radiation Exposure Statement:

This equipment complies with FCC radiation exposure limits set forth for an uncontrolled environment. This equipment should be installed and operated with minimum distance 20cm between the radiator & your body.

Wi-Fi:

Standard	IEEE802.11ac, IEEE802.11a , IEEE802.11b , IEEE 802.11g , IEEE 802.11n
ISM frequency Band	2.4/ 5 GHz
Data Rate	802.11a: 54, 48, 36, 24, 18, 12, 9, 6 Mbps 802.11b: 11, 5.5, 2, 1 Mbps 802.11g: 54, 48, 36, 24, 18, 12, 9, 6 Mbps 802.11n: MCS 0 to 15 for HT20MHz MCS 0 to 15 for HT40MHz 802.11ac: MCS 0 to 8 for HT20MHz MCS 0 to 9 for HT40MHz MCS 0 to 9 for HT80MHz
Modulation Techniques	802.11ac: 256QAM, 64QAM, 16QAM, QPSK, BPSK 802.11a: 64QAM, 16QAM, QPSK, BPSK 802.11b: CCK, DQPSK, DBPSK 802.11g: 64QAM, 16QAM, QPSK, BPSK 802.11n: 64QAM, 16QAM, QPSK, BPSK

<p>Transmit Output Power – 2x2 (Tolerance: ±1.5dBm@2.4GHz ±2dBm@5GHz)</p>	<p>802.11b / CCK : 18 dBm 802.11a : 13 dBm @6,24,36Mbps 12 dBm @48Mbps 10.5 dBm @54Mbps 802.11g / OFDM: 18 dBm@6,9,12,18,24Mbps 17 dBm@36Mbps 16 dBm@48Mbps 16 dBm@54Mbps 2.4G: 802.11n / HT20: 18 dBm@MCS0 16 dBm@MCS7 802.11n / HT40: 17 dBm@MCS0 16 dBm@MCS7 5G: 802.11n / HT20: 12.5 dBm@MCS0 10 dBm@MCS7 802.11n / HT40: 11.5 dBm@MCS0 10 dBm@MCS7 AC: HT20: 10 dBm@MCS7 9 dBm@MCS8 HT40: 8 dBm@MCS8 7 dBm@MCS9 HT80: 7 dBm@MCS8 6 dBm@MCS9</p>
---	---

Appendix 3. Cybersecurity

This appendix is intended for the IT network responsible at the organization where the displaying unit is used. It contains technical information regarding the setup of the IT network and the devices connected to the displaying unit. It also contains information regarding the types of data contained in and transmitted from the displaying unit.

The displaying unit is of low security risk, as:

- No PHI is stored in the displaying unit.
- The displaying unit does not allow any input from external devices (except from Ambu visualization devices and secured software updates).
- Essential functionality is secured in case of network problems.
- The only way to potentially harm the displaying unit is via physical access, which limits the threats from remote threat actors.

Appendix 3.1 Network Setup

When preparing the network for connection to the displaying unit, the following should be considered:

Item	Standards used	Comments
Wireless communication	IEEE 802.11	The device uses a WPA_Supplicant to support WPA2 Wireless communication as TKIP and CCMP. The authentication and integrity of the communication is provided by the underlying FIPS 140-2 compliant chipset wireless driver.
LAN communication	IEEE 802.3 IEEE 802.3ab IEEE 802.3az PICMG3.1	The device uses a standard Gigabit Ethernet controller supporting a 1000base-T interface.
Access test	ICMP / ping	Allowing ease-of-discovery for hospital IT infrastructure
Network adaptor configuration	DHCP	Only configurable through DHCP. Special configurations for the network adaptor such as static IP are currently not supported.
Re-routing		The device does not support re-routing traffic from Wi-Fi to LAN or vice versa, therefore the device cannot act as a NAT (Network Address Translation) gateway.
PACS servers	DICOM	To support a broad range of network infrastructures and PACS servers, the device supports DICOM without CMS (Cryptographic Message Syntax) encryption for transporting images and video to the PACS server.
Ports		There are no open ports, the device firewall only accepts TCP responses for DICOM and replies to ICMP ping requests.

Appendix 3.2 Data at rest and in transit

The displaying unit uses SQLite3 databases to secure information about the scopes, procedures and network configurations. The SQLite database is not accessible from the GUI, but images, videos and a limited log can be exported to a PACS server and/or USB device.

The following exportable data are stored:

Item	Format	Comments
Images	DICOM object / PNG	
Video	DICOM object / MP4 (h.264)	
Ambu Application log	Clear-text format	The log files exported are mainly for troubleshooting purposes by Ambu staff, in case you encounter problems with the displaying unit. The files are compressed in a format more secure than Windows standard compression function. Unzipping the data requires a third party tool (e.g. 7-zip).

Images and videos can be transferred to a PACS server. The following formats and protocols are used during the transfer from the displaying unit to the PACS server:

Item	Format	Protocols	Comments
Images	DICOM object / PNG	DICOM without CMS	Can use either Wi-Fi or LAN communication.
Video	DICOM object / MP4 (h.264)	DICOM without CMS	Can use either Wi-Fi or LAN communication.

Appendix 3.3 Cybersecurity Bill Of Materials (CBOM)

The following main off-the-shelf software components are used in the displaying unit.

The main known vulnerabilities of each component are included with an explanation of, why they are acceptable for this application. Vulnerabilities with a low CVSS score are omitted in this list as a consequence of the low security risk rating of the displaying unit.

Title	Version	Used for	Known vulnerabilities from NVD (CVSS score)
Qt	5.12	Qt is used for the graphical user interface (GUI).	CVE-2019-18281 (7.5) Can cause denial of service, by handcrafting text file containing directional characters. <i>In the displaying unit there are no known interactions which allows text files from a user to be loaded into Qt.</i>
Boost	1.68.0	Boost is used for IO file interaction and asynchronous handling.	<i>The only known exploits in IO file handling for boost are for XSS exploits for web environment, which is not used in displaying unit.</i>
Libyaml	0.6.2	Is used to parse YAML files on the device. YAML files are used for configuration, including keys and values.	CVE-2019-6292 (6.5) CVE-2019-6285 (6.5) CVE-2018-20574 (6.5) CVE-2018-20573 (6.5) 3 of these are handcrafted malicious YAML files causing a denial of service and one causing a stack exhaustion. <i>The displaying unit does not allow any external YAML file to be added to the device.</i>
SQLite	3.22	Main database.	None
Linux	Linux Kernel version 4.4	The embedded Linux kernel is built custom by Ambu.	<i>Many known issues, but none of these are critical to the Displaying Unit. Some of the media and interactions kernel are described below.</i>

Title	Version	Used for	Known vulnerabilities from NVD (CVSS score)
GStreamer	1.14.4	The following plugins are used: v4l2src glupload glcolorconvert vaapiopostproc vaapih264enc matroskamux tcpserver sink tcpclient src filesink qmlgl sink	CVE-2019-9928 (8.8) Allows a heap-based buffer overflow in the RTSP connection parser to potentially allow remote code execution. <i>The displaying unit does not depend directly on RTSP input. It is only used inside the board from EEPROM encoded Embedded Controller.</i>
OpenSSL	1.0.2p	Used to generate the private key and authenticate the public key used to sign the upgrade package.	CVE-2019-1559 (5.9) If an application encounters a fatal protocol error and then calls SSL_shutdown() twice, the OpenSSL can respond different to an invalid padding. <i>The displaying unit validates a signed public key certificate for the upgrade software and isn't applicable for this kind of vulnerability.</i> CVE-2019-12572 (7.8) A vulnerability in the London Trust Media Private Internet Access (PIA) VPN Client 1.0.2 for Windows. <i>Not applicable for displaying unit running Linux without VPN.</i> CVE-2018-0734 (5.9) The OpenSSL DSA signature algorithm has been shown to be vulnerable to a timing side channel attack. <i>The displaying unit is not applicable for this type of attack.</i>
dcmtk	3.6.3	Used for the DICOM protocol communicating to the PACS server.	CVE-2019-1010228 (9.8) OFFIS.de DCMTK 3.6.3 and below is affected by: Buffer Overflow. The impact is: Possible code execution and confirmed Denial of Service. <i>This vulnerability is on the receive server-side for the DICOM engine, the displaying unit only transmits the DICOM and doesn't parse it from outside sources.</i>
RAUC	1.0	Used for system upgrades.	There are no known vulnerabilities.

